

INSPROVET



MATERIAL SANITARIO	<ul style="list-style-type: none"> • AGUJAS Y JERINGAS DESECHABLES 2 - 3 • EXTRACCIÓN DE SANGRE / PERFUSIÓN 4 - 7 • DESINFECTANTES 8 • VENDAS 8 - 11 • TOMA DE MUESTRAS 12 - 13
JERINGAS	<ul style="list-style-type: none"> • JERINGAS PLÁSTICO 14 • JERINGAS DOSIFICADORAS 15 - 17 • JERINGAS REVOLVER 18 - 20 • JERINGAS VACUNADORES 20 - 27
ACCESORIOS GRANJAS	<ul style="list-style-type: none"> • ORDEÑO Y CUIDADO DE UBRES 28 - 37 • CUBOS, BIBERONES Y TETINAS 38 - 43 • COMEDEROS Y BEBEDEROS 44 - 51 • CERCADOS ELÉCTRICOS 52 - 71 • CONTROL DE PLAGAS 72 - 75 • CUIDADO DE CASCOS 76 - 85 • CUIDADOS DENTALES 86 • CORTA COLMILLOS 87 • DESCORNADORES 88 - 89 • EMASCULADORES 90 - 91 • CORTA COLAS 91 - 92 • ESQUILADORAS 93 - 100 • TRABAS Y ELEVADORES 101 • EMPUJADORES ELÉCTRICOS 102 - 105 • ACCESORIOS CERBATANAS Y RIFLES 106 - 107 • ANILLAS NASALES 108 - 110 • LAZOS Y TRABONES 111 - 112 • AMARRES, COLLARES Y CABEZADAS 113 - 121 • EQUITACIÓN 122 - 124 • BRUZAS Y RASQUETAS 125 - 126 • PORCINO 127 • AVÍCOLA 128 - 132 • LÁMPARAS Y BOMBILLAS 132 - 133 • PISTOLA SACRIFICIO 134 • CAÑÓN ESPANTAPÁJAROS 134 • BANDEJAS DESINFECCIÓN 135 • CEPILLOS, RECOGEDORES Y PALAS 136 - 141
INSTRUMENTAL VETERINARIO	<ul style="list-style-type: none"> • IMANES, TRÓCARES Y SONDAS GÁSTRICAS 142 - 144 • OBSTETRICIA PARTOS 145 - 148 • INSEMINACIÓN 149 - 157 • OTOSCOPIOS Y FONENDOSCOPIOS 158 - 159 • TERMÓMETROS 160 - 163 • PESAJE 164 - 166 • LABORATORIO (MICROSCOPIO, DIGESTOR, ETC) 167 • INSTRUMENTAL (TIJERAS, PINZAS, ETC) 168 - 181 • SUTURAS 182 - 186
VESTUARIO Y EPIS	<ul style="list-style-type: none"> • GORROS, MASCARILLAS Y GAFAS 187 • BOTAS Y CUBRE ZAPATOS 188 - 190 • GUANTES 190 - 195 • BATAS, DELANTALES Y PETOS 195 - 197 • BUZOS 198
IDENTIFICACIÓN VISUAL	<ul style="list-style-type: none"> • TATUADORES 199 - 203 • SPRAYS Y LÁPICES MARCADORES 204 - 205 • SACABOCADOS 206 • MARCAS MANUALES 207 • COLLARES Y PULSERAS 208 - 209 • CROTALES ALLFLEX 210 - 212 • CROTALES ZTAG 213 • CROTALES CROMASA 214 - 218
IDENTIFICACIÓN ELECTRÓNICA	<ul style="list-style-type: none"> • MICROCHIPS 219 • LECTORES MICROCHIPS 220
MASCOTAS	<ul style="list-style-type: none"> • PASEO (COLLARES, ARNESES Y BOZALES ...) 221 - 227 • SNACKS PERROS 228 - 229 • COMEDEROS Y BEBEDEROS 230 - 231 • FÉRULAS Y COLLARES ISABELINOS 232 - 233 • TRANSPORTINES 234 - 237 • EDUCACIÓN 238

ÍNDICE

A		C	
ABREBOCAS VACUNO Y EQUINO	86	CABEZADAS CABALLOS	120 - 121
ABREBOCAS PERROS	240	CABEZADAS VACAS	118
ACEITE LUBRICANTE ESQUILADORAS ELÉCTRICAS	100	CABEZALES BASTONES PATAS	111
ADAPTADOR TALADRO AISLADORES	71	CABLES CERCADOS ELÉCTRICOS	63
AFILADORA ELÉCTRICA CUCHILLAS Y PEINES	100	CADENAS PARTOS	144
AFILADORES	83	CADENAS SUJECIÓN CABALLOS	122
ÁGRAFES	148	CAJA PLÁSTICO INSTRUMENTOS	221
AGUA OXIGENADA	8	CAJAS INSTRUMENTAL	168
AGUJAS DARDOS CERBATANA	106	CALENTADORES LECHE	30
AGUJAS DARDOS RIFLE ANESTÉSICO	107	CÁMARA CONSERVACIÓN SEMEN	154
AGUJAS DESECHABLES	3	CÁMARAS RECUENTO BUNKER	167
AGUJAS EXTRACCIÓN SANGRE	4	CAMISAS CABALLOS	123
AGUJAS FLOTANTES	5	CAMISAS SANITARIAS	151
AGUJAS GARROCHA	27	CÁNULAS DOSIFICADORAS	15
AGUJAS HIPODERMICAS	2	CÁNULAS MAMARIAS	36
AGUJAS MAMARIAS	36	CÁNULAS PEGAMENTOS TACOS	77
AGUJAS SUTURA	182 - 183	CAÑÓN ESPANTAPÁJAROS	134
AGUJAS SUTURA VAGINAL	148	CARTUCHOS PEGAMENTO TACOS	77
AGUJAS TUBERCULINA	26	CARTUCHOS PISTOLA SACRIFICIO	134
AISLADORES CERCADOS ELÉCTRICOS	66 - 69	CARTUCHOS RIFLE ANESTÉSICO	106
ALARGADORES GOTERO	6	CATÉTERES INSEMINACIÓN PERRAS	153
ALCOHOL DESINFECTANTE	8	CATÉTERES INSEMINACIÓN PORCINO	152
ALGODÓN HIDRÓFILO	8	CATÉTERES INTRAVENOSOS	5
ALICATES CORTA COLMILLOS	87	CATÉTERES URINARIOS	5
ALQUITRÁN DE HAYA	79	CATÉTERES UTERINOS	149
AMARRES	113 - 114	CATGUT SUTURA	185
AMBIENTADORES	75	CAUTERIZADOR	169
ANILLAS NASALES	108	CAZOS	51
ANILLAS PLÁSTICO AVES	132	CENCERROS	117
ANTEOJOS GALLINAS	132	CEPILLOS LIMPIEZA	137
ANTITETAS	37	CEPILLOS LIMPIEZA GANADO	136
ANULADORES PEZONERA	31	CEPILLOS LIMPIEZA LECHERAS	29
APLICADOR IMANES ESOFÁGICOS	142	CHAQUETAS	196
APLICADOR BOLOS	218	CHUBASQUEROS CORDEROS	41
APOSITOS GASA	8	CIERRES TENSORES	65
ARCO INSEMINACIÓN PORCINO	153	CINCHAS SUJECIÓN TRANSPORTE	113
ARNÉS PERROS VEHÍCULOS	236	CINTAS SUPERCONDUCTORAS CERCADOS ELÉCTRICOS	62
ARNÉS ANTI-TIRO PERROS	226	CINTAS DE PESAJE	166
ARNÉS MARCADOR	156	CINTAS SUTURA VAGINAL	148
ARNÉS PERROS	221 - 225	CLAMPS	147
ARNÉS RECUPERACIÓN	232	CLAVOS HERRADURAS	81
AVISADOR PARTOS	145	COLLARES ADIESTRAMIENTO PERROS	238
B		COLLARES ANTI-TIRO PERROS	226
BALANZAS	165	COLLARES CIERRE OVINO	208
BANDEJA PLÁSTICO INSTRUMENTOS	221	COLLARES CUERO CENCERROS	116
BANDEJAS DESINFECCIÓN CALZADO	135	COLLARES ISABELINOS	233
BANDEJAS GUÍAS PORCINO	102	COLLARES LONA OVINO	116
BANDEJAS TEST MAMITIS	32	COLLARES NYLON IDENTIFICACIÓN	208
BAÑO MARÍA	154	COLLARES NYLON OVINO / VACUNO	208
BÁSCULAS DE SUELO	164	COLLARES PERROS	224
BASTONES MEDICIÓN	166	COLLARES TUBULARES	114
BASTONES PATAS	111	COLLARES VACAS	119
BATAS	195 - 197	COMEDEROS GALLINAS	129
BATERÍAS ESQUILADORAS ELÉCTRICAS	95 - 98	COMEDEROS PERROS	230 - 231
BATERÍAS PASTORES ELÉCTRICOS	60	COMEDEROS PORCINO	45
BATIDORES LECHE	29	COMEDEROS VACUNO	49 - 50
BEBEDEROS	46 - 48	COMPROBADORES CERCADOS ELÉCTRICOS	61
BEBEDEROS AVES	130 - 131	CONECTORES GOTERO	6
BEBEDEROS CHUPETE	44 - 45	CONECTORES PASTORES ELÉCTRICOS	59
BEBEDEROS PERROS	231	CONTADOR ANIMALES	166
BIBERONES	42 - 43	CONTENEDORES SEGURIDAD	13
BISTURÍS	169	CORREAS PERROS	222 - 225
BOCADOS CABALLOS	123	CORTA COLAS	91 - 92
BOLSAS CALOSTRO	41	CORTA COLMILLOS	87
BOLSAS DE TRANSFUSIÓN	6	CORTA PAJUELAS	151
BOLSAS HIGIÉNICAS PERROS	221	CROTALES IDENTIFICACIÓN VISUAL	208 - 218
BOMBAS ESTOMACALES	142	CROTALES IDENTIFICACIÓN ELECTRÓNICA	219 - 220
BOMBILLAS INFRAROJOS	133	CROTALES MUESTRA A.D.N.	219
BOTAS	188 - 189	CUBOS PLÁSTICO ORDEÑO	31
BOTAS CUBRE CALZADO	190	CUBOS GALVANIZADOS	29
BOTES RECOGIDA SEMEN	153	CUBOS TETÓN	38 - 39
BOTES RECOGIDA MUESTRAS	12	CUBRE BARBAS DESECHABLES	187
BOZALES CABALLOS	122	CUBRE OBJETOS MICROSCOPIO	167
BOZALES PERROS	226 - 227	CUBRE ZAPATOS	190
BOZALES TERNEROS	118	CUCHARAS RECOGIDA MUESTRAS	13
BRUZAS	125	CUCHILLAS CASCOS	85
BURDIZOS	91	CUCHILLAS CESÁREA	147
BUZOS	198	CUCHILLAS ESQUILADORAS ELÉCTRICAS	94 - 99
		CUERDAS CABEZADAS	122
		CUERDAS PARTOS	144
		CUTÍMETROS	166

D	
DARDOS CERBATANA	106
DARDOS RIFLE ANESTÉSICO	107
DELANTALES	196 - 197
DEMOTEC	76 - 77
DENSÍMETROS CALOSTRO	32
DEPRESORES LINGUALES	239
DERIVADOR RAYOS	71
DESCONGELADOR PAJUELAS	154
DESCORNADORES	88 - 89
DETECTOR METALES	142
DETECTORES CELO	156
DETECTORES GESTACIÓN	155
DIGESTOR TRIQUINA	167
DILATADORES DE MAMAS	34
DINAMÓMETROS	165
DISCOS CASCOS	80
DISPENSADORES BOLSAS HIGIÉNICAS	221
DISPOSITIVOS CUAJAR	143

E	
ELASTRATORS	91
ELEVADORES	101
EMASCULADORES	90
EMPUJADORES ELÉCTRICOS	102 - 105
ENGANCHE SEGURIDAD VEHÍCULOS	236
ENVASES ESTERILIZACIÓN DESECHABLES	168
ESCALPELO LINDE	147
ESCOBAS	140
ESCOBILLONES	13
ESPARADRADO	8
ESPÉCULOS NAALES	157
ESPÉCULOS VAGINALES	157
ESPONJAS LIMPIEZA TUBOS	28
ESQUILADORAS ELÉCTRICAS	94 - 99
ESTUFA CULTIVOS	154
EVACUADORES	36
EXTERMINADORES INSECTOS	74 - 75
EXTRACTORES PARTOS	145

F	
FÉRULAS	232
FILTROS PARA LECHE	28
FILTROS PARA TUBO	28
FONENDOSCOPIOS	159
FORCEPS	146
FORRAJERAS	50 - 51
FUNDA PROTECTORA AUTOMOVIL	236
FUNDAS SILLAS MONTAR	124
FUSTAS	122

G	
GAFAS PROTECCIÓN	190
GANCHOS OCULARES	146
GARROCHA	27
GEL ECOGRAFÍA	155
GEL HIDROALCOHOLICO	8
GEL LUBRICANTE	151
GOMAS CAUCHO	91
GOMAS SUJECCIÓN TRANSPORTE	113
GORROS DESECHABLES	187
GOTEROS	6
GRADILLAS TUBOS EXTRACCIÓN SANGRE	4
GRAPADORAS DESECHABLES	186
GRAPAS CERDOS	109
GRASA CASCOS	79
GUANTES	192 - 195
GUANTES PROTECCIÓN	191
GUÍAS PARA CUERNOS	5260
GUILLOTINAS PASTILLAS	239

H	
HERRADURAS	81
HILOS CERCADOS ELÉCTRICOS	62
HISOPOS	13
HOJAS BISTURÍ	169
HORCAS	141
HUEVOS POSTIZOS	128

I	
IMANES ESOFÁGICOS	142
IMPERDIBLES PROLAPSOS	147
INCUBADORAS	128
INSEMINADORES	149 - 150
INTERRUPTOR CORRIENTE CERCADOS ELÉCTRICOS	71
INTRODUCTORES PASTILLAS	239
INYECTOR INTRADÉRMICO DERMOJET	27

J	
JARRAS COMPROBACIÓN LECHE	29
JAULAS CAPTURA	73
JAULAS TRANSPORTE PERROS	234
JERINGAS DESECHABLES	3
JERINGAS DOSIFICADORAS	15 - 17
JERINGAS METAL	14
JERINGAS MICROCHIPS	219
JERINGAS PLÁSTICO	14
JERINGAS REVOLVER	18 - 20
JERINGAS VACUNADOR	20 - 26
JUGUETES PORCINO	127

K	
KIT AUTOPSIAS	177

L	
LÁMPARAS BOMBILLAS	132
LANCETAS	36
LAPIZ MARCADORES GANADO	204 - 205
LAPIZ SOSA DESCORNAR	89
LAZOS CAPTURA PERROS	73
LAZOS MORROS	111
LECTORES MICROCHIPS	220
LEGRAS	85
LIMAS CASCOS	83
LIMAS DENTALES CABALLOS	86
LIMAS ELÉCTRICAS COLMILLOS	87
LIMPIADOR OTOSCOPIOS Y ESPÉCULOS	157
LIMPIADORES CALZADO	136
LINTERNA	221

M	
MANDIL CARNEROS	156
MANGOS CEPILLOS, ESCOBAS ...	139
MANGOS BISTURÍ	169
MANGOS SUJECCIÓN SIRGAS DESCORNAR	89
MANGUITOS ORDEÑO	30
MANTAS TERNEROS	41
MÁQUINA PARA DISCOS	80
MARCAS MANUALES	207
MARTILLOS CASCOS	83
MARTILLOS VETERINARIOS	180
MASCARILLAS	187
MEDIDOR PH	32
MEDIDOR PH Y CLORO	163
MICROCHIPS INYECTABLES	219
MICROSCOPIO	167
MOSQUETONES	115

N	
NARIGUERAS	110
NEUTRALIZADORES OLORES	134
NÚMEROS TATUADORES GANADO	201 - 202
NÚMEROS PINTURA GANADO	199

O	
OTOSCOPIOS	158
OVOSCOPIO	128

P	
P.G.A. SUTURA	186
PAJUELAS	151
PALAS	138 - 141
PALETAS ARREADORAS PORCINO	102
PANTALONES	196 - 197
PAÑOS LIMPIEZA UBRES	30

PAÑOS PARA CAMPO	168
PASADOR SAND PARTOS	144
PASADORES HORQUILLA	114
PASTA DESCORNAR	89
PASTILLAS ARNÉS MARCADOR	156
PASTORES ELÉCTRICOS	56 - 58
PEGAMENTOS TACOS CASCOS	77
PEINES ESQUILADORAS ELÉCTRICAS	94 - 99
PELA COLAS PARA TALADRO	100
PELADOR AVES	129
PETOS	196
PILAS EMPUJADORES ELÉCTRICOS	105
PINTURA PARA GANADO	199
PINZAS CAPTURA GATOS	73
PINZAS CIRUGÍA	172 - 179
PINZAS QUITAGRAPAS	186
PINZAS SACRIFICIO AVES	128
PINZAS SUJETA COLAS	110
PIPETAS	13
PISTOLA APLICADORA PEGAMENTOS TACOS	77
PISTOLA SACRIFICIO	134
PISTOLAS LIMPIEZA	28
PISTOLAS MICROCHIPS INYECTABLES	219
PLACAS MICROSCOPIO / TRIQUINOSCOPIO	167
PLACAS SEÑALIZACIÓN	71
PLÉXÍMETRO VETERINARIO	180
PLUVIÓMETROS	163
PORTA AGUJAS SUTURA	181
PORTA FRASCOS	26
PORTA PERROS TOWBOX	237
PORTA TUBOS EXTRACCIÓN SANGRE	4
POSTES CERCADOS ELÉCTRICOS	64
POTROS CASTRADORES	91
POVIDONA	8
PRECINTOS SEGURIDAD	209
PROLAPSOS	147
PROTECTORES DE HOMBRO	195
PROTECTORES MOSCAS CABALLOS	121
PROTECTORES SILLAS MONTAR	124
PUJAVANTES	84
PULSERAS OVINO / VACUNO	209
PULVERIZADORES DESINFECCIÓN PEZONES	33

R

RASQUETAS	126
RASTRILLOS	141
RASURADORAS DESECHABLES	100
REACTIVOS TESTS	32
REANIMADOR TERNEROS	146
RECOGEDORES CINTA / HILO	64
RECOGEDORES LIMPIEZA	137 - 140
RED SEPARACIÓN VEHÍCULOS	236
REDES CERCADOS ELÉCTRICOS	64
REFRACTÓMETROS	32
RIENDAS	122
ROTULADORES CROTALES	212 - 213

S

SACABOCADOS	206
SEDAS SUTURA	184
SEPARADORES CIRUGÍA	173
SEPARADORES LECHE	31
SET PARA FRASCO	5
SILLA ORDEÑO	31
SILLAS MONTAR	124
SIRGAS DESCORNAR	89
SNACKS PERROS	228 - 229
SONDAS UTERINAS	150
SONDAS ESOFÁGICAS	144
SONDAS GÁSTRICAS	144
SONDAS IMANES ESOFÁGICOS	142
SONDAS URETRALES	7
SOPLETE LLAMA FRÍA	30
SOPORTES CUBOS TETÓN	39
SOPORTES SILLAS MONTAR	124
SOSTENES PARA UBRES	33
SPRAY ADOPCIÓN CORDEROS	148
SPRAY ALQUITRÁN	78
SPRAY ANTI CANIBALISMO	127
SPRAY BOARMATE	152
SPRAY LUBRICANTE ESQUILADORAS ELÉCTRICAS	100
SPRAY MARCADOR GANADO	204 - 205

SPRAY SEPTIJECT	78
-----------------	----

T

TACOS MADERA	77
TACOS PLÁSTICO	77
TAMPONES TINTA GANADO	203
TATUADORES GANADO	200 - 202
TENAZAS ANILLAS NASALES	
TENAZAS CASCOS	82
TENAZAS CERCADOS ELÉCTRICOS	71
TENAZAS CROTALES GANADO	212 - 218
TENAZAS GRAPAS CERDOS	109
TENAZAS MARCAS MANUALES	207
TERMÓMETROS	160 - 163
TETINAS	40
TETINAS PANEL	39
TIJERAS CASCOS	84
TIJERAS CIRUGÍA	170 - 171
TIJERAS ESQUILAR	93
TIJERAS MARCAR GANADO	206
TINTA TATUADORES	203
TOALLITAS DESINFECCIÓN PORCINO	152
TOALLITAS DESINFECCIÓN UBRES	30
TRABAS VACAS	101
TRABONES	112
TRAMPAS ROEDORES	72
TRANSPORTINES	234 - 235
TRITURADORES PASTILLAS	239
TRÓCARES	143
TUBOS EXTRACCIÓN SANGRE	4
TUBOS PARA AIRE	28
TUBOS PARA LECHE	28
TUBOS RECOGIDA MUESTRAS LECHE	31

U

UNGÜENTOS PARA UBRES	35
----------------------	----

V

VAGINAS ARTIFICIALES	153
VAINAS INSEMINACIÓN	150
VALLAS INVISIBLES	238
VÁLVULAS CUBOS TETÓN	38
VASOS DESIFECCIÓN PEZONES	33
VENDAS	8 - 11
VENDAS ALQUITRÁN	79
VENDAS TRABAJO CABALLOS	124
VENDAS YUTE	79
VIDIAS	81

Z

ZAPATOS PROTECTORES	78
---------------------	----

CONDICIONES GENERALES DE VENTA

ENVÍOS

- La entrega de los pedidos se realizará en la dirección designada libremente por el usuario. De tal forma, el prestador no asume responsabilidad alguna por cuando la entrega del producto o servicio no llegue a realizarse como consecuencia de que los datos facilitados por el cliente sean falsos, inexactos o incompletos o cuando la entrega no pueda efectuarse por causas ajenas a la empresa de envíos, asignada para tal efecto, como lo es la ausencia del destinatario.
- El periodo de reclamación para incidencias en envíos será de 7 días naturales después de la fecha de recepción del mismo. Una vez transcurrido dicho plazo toda reclamación quedará invalidada.
- Nuestros productos se entienden situados en nuestro almacén. Los gastos originados por el transporte serán incluidos en factura.

PRECIOS Y FACTURACIÓN

- Los precios aplicables a cada producto serán los publicados en catálogo. Los precios que se indican respecto a cada producto no incluyen el Impuesto sobre el Valor Añadido (IVA) u otros impuestos que pudieran ser aplicables y en todo caso se expresarán en la moneda Euro (€). Dichos precios, salvo que se indique expresamente lo contrario, no incluyen los gastos de envío.
- El pago del importe de las compras efectuadas tendrá un vencimiento de 30 días a partir de la fecha de factura.
- Debido a los gastos mínimos de facturación y manipulación de las mercancías, las facturas con importes inferiores a 60€ se girarán a la vista.
- Para cualquier información sobre el pedido, el usuario contará con el teléfono de atención a clientes de Insprovet s.l. que es 948 312848 o vía correo electrónico a la dirección de e-mail insprovet@insprovet.net. En todo caso deberá indicarse en el asunto del mensaje el número de albarán de la compra efectuada.
- Los artículos que pudieran aparecer en el catálogo general de ganadería se regirán por el precio que marque dicho catálogo.

DEVOLUCIONES

- Insprovet s.l. se compromete única y exclusivamente a la reposición del material que pudiera mostrarse defectuoso, no aceptando ninguna devolución transcurridos 30 días naturales desde la fecha de envío y sin que previamente haya sido comprobado y aceptado por nuestro personal. Salvo que la devolución sea realizada por defectos en el producto, los gastos relativos al envío serán asumidos por parte del usuario. En todo caso el producto deberá ser devuelto en su embalaje original y en perfecto estado. En caso contrario la devolución no será aceptada.
- El derecho de devolución no podrá aplicarse a productos personalizados o que por razones de higiene y salubridad u otras excepciones legalmente contempladas no sean susceptibles de éste derecho.

GARANTÍAS APLICABLES

- Todos los productos cuentan con un periodo de garantía, conforme a los criterios y condiciones descritas en el Real Decreto Legislativo 1/2007, de 16 de noviembre, por el que se aprueba el texto refundido de la Ley General para la Defensa de los Consumidores y Usuarios y otras leyes complementarias.
- La empresa Insprovet s.l. no será responsable de las lesiones, pérdidas, daños humanos o animales derivados del uso incorrecto de los productos.

LEYES APLICABLES Y JURISDICCIÓN

- Estas condiciones se regirán o interpretarán conforme a la legislación española en aquello que no este expresamente establecido. El prestador y el usuario, acuerdan someter cualquier controversia que pudiera suscitarse de la prestación de los productos o servicios objeto de éstas Condiciones, a los Juzgados y Tribunales del domicilio del usuario. En el caso de que el usuario tenga su domicilio fuera de España, el prestador y el usuario, renuncian expresamente a cualquier otro foro, sometiéndose a los Juzgados y Tribunales de la ciudad de Berain (Navarra - España).
- Insprovet s.l. se reserva el derecho a anular o modificar total o parcialmente este catálogo incluyendo los precios sin previo aviso, así como la variación o supresión de cualquiera de los productos, no haciéndose responsable de los daños o molestias ocasionados.

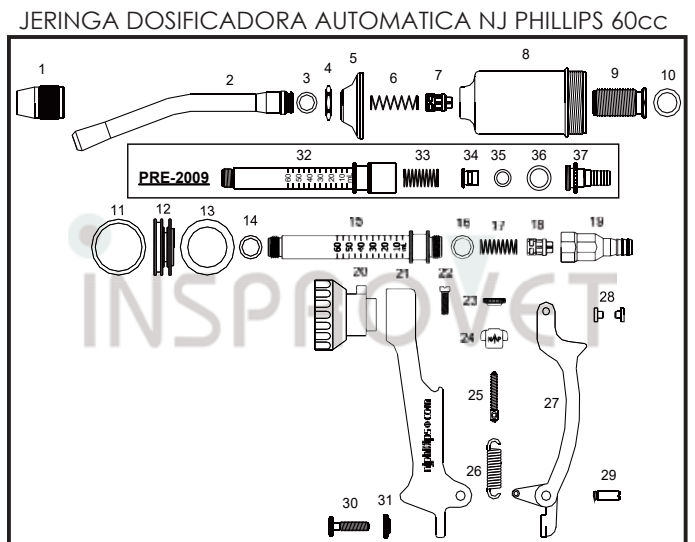
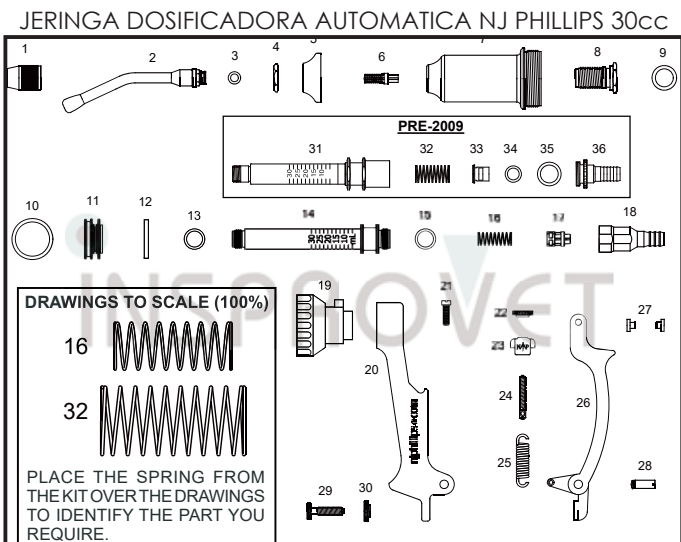

JERINGA REVOLVER DIAMANT



JERINGA REVOLVER ROUX

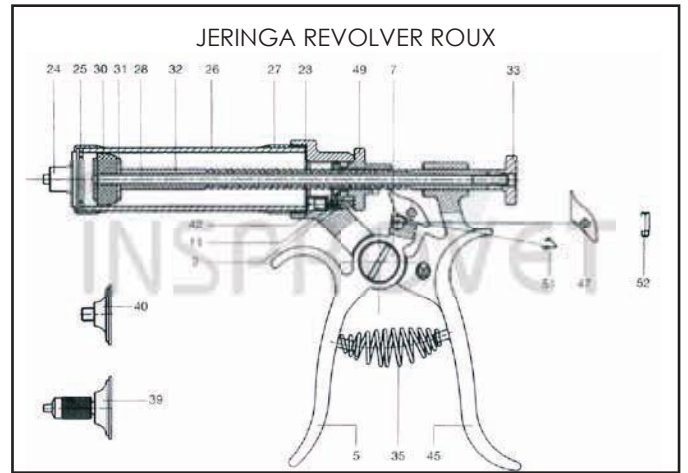

JERINGA REVOLVER HAUPTNER MUTO



JERINGA REVOLVER HAUPTNER MUTO EXPRESS

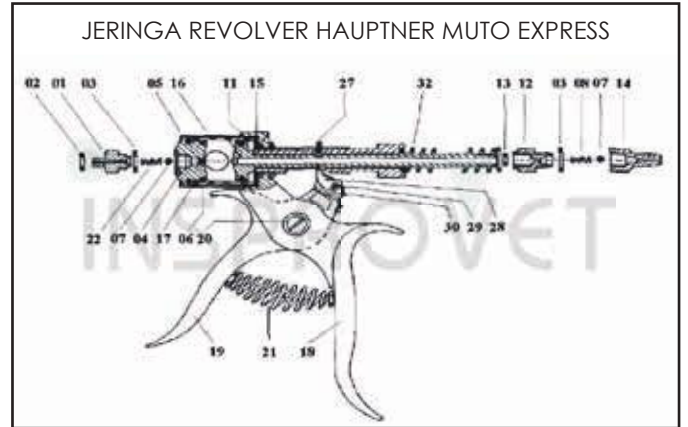

VACUNADOR HENKE VET-MATIC

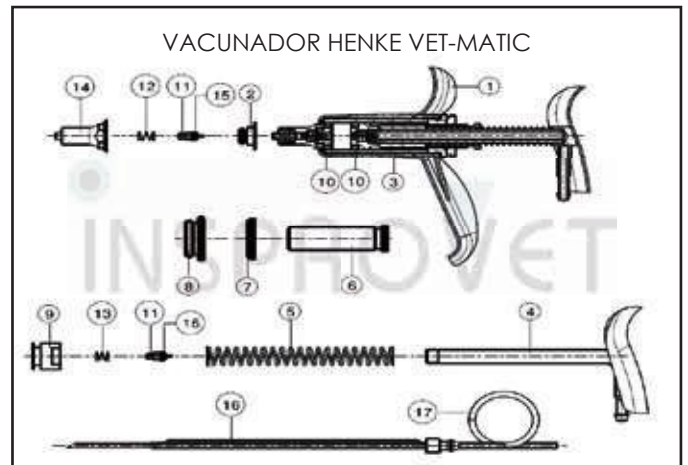

JERINGA REVOLVER NJ PHILLIPS

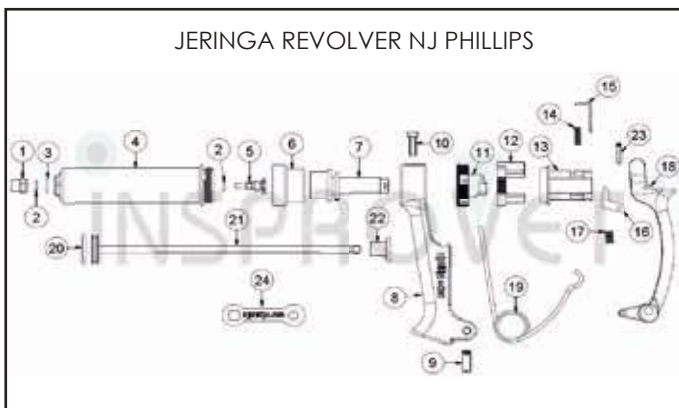

VACUNADOR HENKE FERRO-MATIC

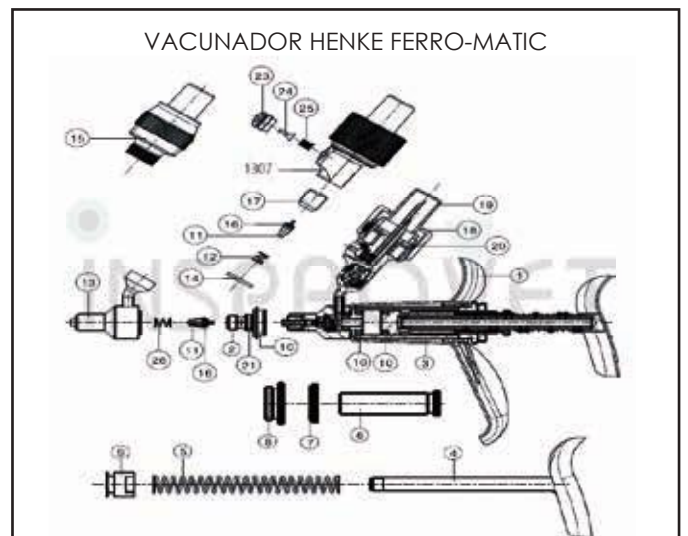

VACUNADOR HENKE TBC TUBERCULINA



VACUNADOR SOCOREX AGUJA ASCENSION

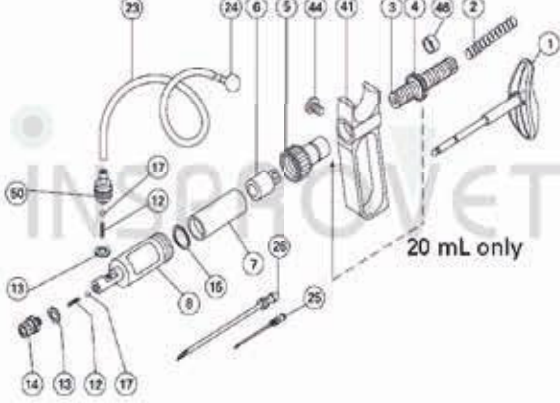

VACUNADOR SOCOREX PORTA FRASCOS

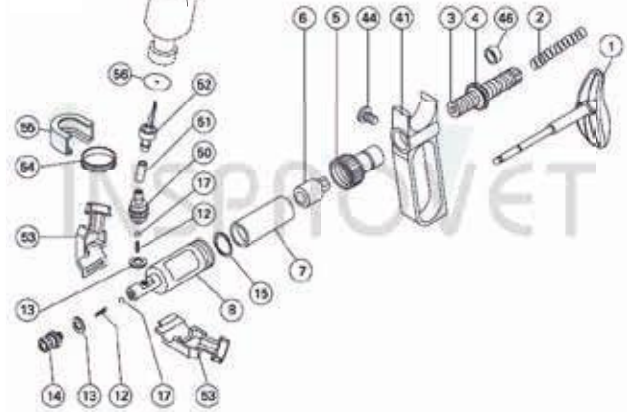

VACUNADOR MASTER LINE

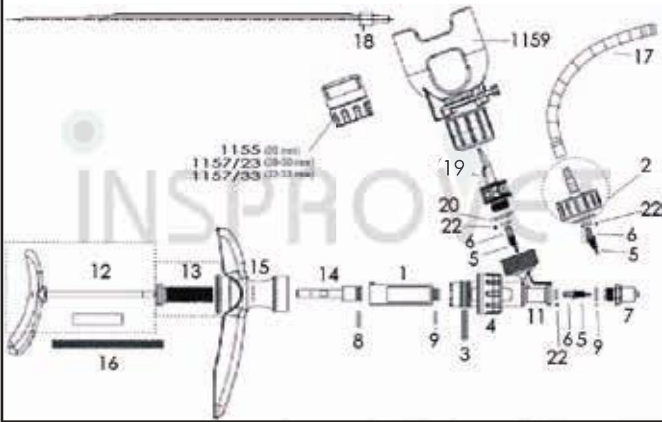

VACUNADOR SOCOREX AGUJA ASCENSION

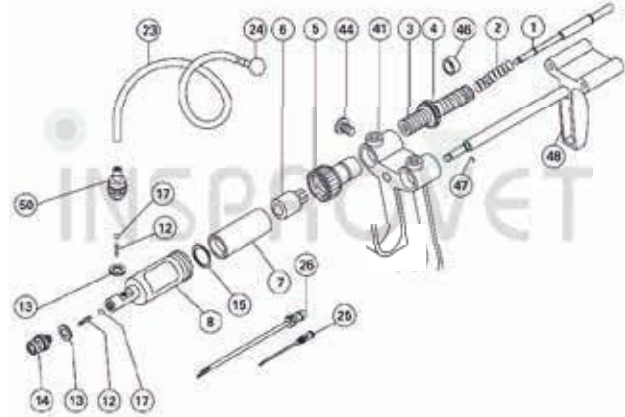

VACUNADOR NJ PHILLIPS

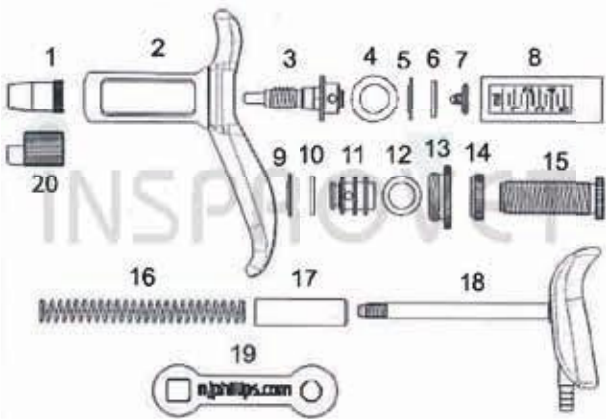

VACUNADOR SERENA AGUJA ASCENSION



VACUNADOR SERENA PORTAFRASCOS



VACUNADOR SERENA CON PROLONGADOR



INSPROVET



Agujas hipodérmicas

- Cono L/L
- Caja de 12 uds

Ref.	Medidas	Gauge	PVP	IVA
100	10 x 1.0	19G x 3"	2,340 €	21
101	10 x 1.3	18G x 3/8"	2,340 €	21
102	10 x 1.5	17G x 3/8"	2,340 €	21
103	13 x 1.3	18G x 1/2"	2,340 €	21
104	15 x 1.0	19G x 5/8"	2,340 €	21
105	15 x 1.3	18G x 5/8"	2,340 €	21
106	15 x 1.5	17G x 5/8"	2,340 €	21
107	15 x 1.8	15G x 5/8"	2,340 €	21
108	15 x 2.0	14G x 5/8"	2,340 €	21
109	20 x 1.0	19G x 3/4"	2,340 €	21
110	20 x 1.3	18G x 3/4"	2,340 €	21
111	20 x 1.5	17G x 3/4"	2,340 €	21
112	20 x 1.8	15G x 3/4"	2,340 €	21
113	20 x 2.0	14G x 3/4"	2,340 €	21
193	25 x 1.0	19G x 1"	2,340 €	21
114	25 x 1.3	18G x 1"	2,340 €	21
115	25 x 1.5	17G x 1"	2,340 €	21
116	25 x 1.8	15G x 1"	2,340 €	21
117	25 x 2.0	14G x 1"	2,340 €	21
118	30 x 1.3	18G x 1 1/4"	2,340 €	21
119	30 x 1.5	17G x 1 1/4"	2,340 €	21
120	30 x 1.8	15G x 1 1/4"	2,340 €	21
121	30 x 2.0	14G x 1 1/4"	2,340 €	21
122	35 x 1.2	18G x 1 3/8"	2,340 €	21
123	35 x 1.5	16G x 1 3/8"	2,340 €	21
124	35 x 1.8	15G x 1 3/8"	2,340 €	21
125	35 x 2.0	14G x 1 3/8"	2,340 €	21
126	40 x 1.2	18G x 1 1/2"	2,340 €	21
127	40 x 1.5	16G x 1 1/2"	2,340 €	21
128	40 x 1.8	15G x 1 1/2"	2,340 €	21
129	40 x 2.0	14G x 1 1/2"	2,340 €	21
194	45 x 1.5	16G x 1 3/4"	2,340 €	21
130	45 x 1.8	15G x 1 3/4"	2,340 €	21
131	45 x 2.0	14G x 1 3/4"	2,340 €	21
132	50 x 2.0	14G x 2"	2,340 €	21



Agujas hipodérmicas Henke Premium

- Cono L/L
- Caja de 10 uds

Ref.	Medidas	Gauge	Color	PVP	IVA
134	10 x 1.0	19G x 3/8"	Crema	5,850 €	21
135	15 x 1.0	19G x 5/8"	Crema	5,850 €	21
137	15 x 1.2	18G x 5/8"	Rosa	5,850 €	21
139	15 x 1.4	17G x 5/8"	Granate	5,850 €	21
141	15 x 1.6	16G x 5/8"	Blanco	5,850 €	21
143	15 x 1.8	15G x 5/8"	Gris	5,850 €	21
145	20 x 1.0	19G x 3/4"	Amarillo	5,850 €	21
147	20 x 1.4	17G x 3/4"	Granate	5,850 €	21
149	20 x 1.6	16G x 3/4"	Blanco	5,850 €	21
151	20 x 1.8	15G x 3/4"	Gris	5,850 €	21
153	20 x 2.0	14G x 3/4"	Verde	5,850 €	21
152	25 x 1.4	17G x 1"	Granate	5,850 €	21
154	25 x 1.6	16G x 1"	Blanco	5,850 €	21
156	25 x 1.8	15G x 1"	Gris	5,850 €	21
158	25 x 2.0	14G x 1"	Verde	5,850 €	21
159	30 x 1.6	16G x 1 1/4"	Blanco	5,850 €	21
160	30 x 1.8	15G x 1 1/4"	Gris	5,850 €	21
162	30 x 2.0	14G x 1 1/4"	Verde	5,850 €	21
163	35 x 1.4	17G x 1 3/8"	Granate	5,850 €	21
164	35 x 1.6	16G x 1 3/8"	Blanco	5,850 €	21
166	35 x 1.8	15G x 1 3/8"	Gris	5,850 €	21
168	35 x 2.0	14G x 1 3/8"	Verde	5,850 €	21
169	40 x 1.8	15G x 1 1/2"	Gris	5,850 €	21
170	40 x 2.0	14G x 1 1/2"	Verde	5,850 €	21
172	50 x 2.0	14G x 2"	Verde	5,850 €	21



Agujas desechables

- Caja de 100 uds

Ref.	Medida	Color	Gauge	PVP	IVA
177	10 x 0.8	Verde	21G x 3/8"	5,750 €	21
174	13 x 0.9	Amarillo	20G x 1/2"	3,650 €	21
197	16 x 0.5	Naranja	25G x 5/8"	3,185 €	21
191	16 x 0.8	Verde	21G x 5/8"	3,185 €	21
176	16 x 1.1	Blanco	19G x 5/8"	3,650 €	21
198	25 x 0.6	Azul	23G x 1"	3,185 €	21
178	25 x 0.8	Verde	21G x 1"	3,185 €	21
180	25 x 0.9	Amarillo	20G x 1"	3,185 €	21
196	25 x 1.1	Crema	19G x 1"	3,185 €	21
181	25 x 1.25	Rosa	18G x 1"	3,185 €	21
189	25 x 1.6	Blanco	16G x 1"	5,200 €	21
188	38 x 1.6	Blanco	16G x 1"	18,950 €	21
195	38 x 2.1	Verde	14G x 1"	22,900 €	21
183	40 x 0.8	Verde	21G x 1 1/2"	3,185 €	21
186	40 x 1.1	Crema	19G x 1 1/2"	3,650 €	21
185	40 x 1.2	Rosa	18G x 1 1/2"	3,185 €	21
192	40 x 1.6	Blanco	16G x 1 1/2"	5,300 €	21
184	40 x 1.8	Gris	15G x 1 1/2"	5,980 €	21
179	60 x 2.1	Blanco	14G x 2 1/2"	28,900 €	21
199	80 x 2.1	Blanco	14G x 3"	36,950 €	21



Jeringas desechables de 2 cuerpos

- Cono L/L

Ref.	Capac.	Cant.	PVP	IVA
300	2 cc	100	4,990 €	21
305	5 cc	100	5,990 €	21
310	10 cc	100	9,150 €	21
315	20 cc	50	7,590 €	21
318	50 - 60 cc	30	22,980 €	21



Jeringas desechables de 3 cuerpos

- Cono L/L
- * Con aguja de 16 x 0.5
- ** Con aguja de 25 x 0.6

Ref.	Capac.	Cant.	PVP	IVA
320	1 cc	100	6,390 €	21
322 *	1 cc	100	10,890 €	21
325	2 cc	100	6,300 €	21
326 **	2 cc	100	10,950 €	21
330	5 cc	100	6,590 €	21
335	10 cc	100	10,880 €	21
340	20 cc	50	7,900 €	21
345	50 cc	25	10,890 €	21
350	100 cc	1	1,650 €	21



Tubos de extracción de sangre

Ref.	Cap.	Modelo	Color	Tubo	Cant.	Marca	PVP	IVA
230/40	5 ml	Vacío	Rojo	Cristal	40	BD	8,980 €	21
250	10 ml	Vacío	Rojo	Plástico	100	BD	21,950 €	21
236	4 ml	EDTA	Morado	Plástico	100	BD	22,950 €	21
237	10 ml	EDTA	Morado	Plástico	100	BD	23,850 €	21
255	4 ml	Heparina	Verde	Plástico	100	BD	34,950 €	21
258	10 ml	Heparina	Verde	Plástico	100	BD	34,950 €	21
245/50	4.5 ml	Vacío	Rojo	Plástico	50	Vacurette	8,250 €	21
245/CB *	4.5 ml	Vacío	Rojo	Plástico	50	Vacurette	8,950 €	21
243	9 ml	Vacío	Rojo	Plástico	50	Vacurette	12,650 €	21
247/4	4 ml	EDTA	Morado	Plástico	50	Vacurette	8,950 €	21
247/9	9 ml	EDTA	Morado	Plástico	50	Vacurette	12,950 €	21
249/4	4 ml	Heparina	Verde	Plástico	50	Vacurette	10,495 €	21
249/9	9 ml	Heparina	Verde	Plástico	50	Vacurette	12,950 €	21

* Con código de barras



Agujas de extracción de sangre

- Cajas de 100 uds
- * Extracción múltiple

Ref.	Medida	Gauge	Marca	PVP	IVA
213 *	25 x 0.9	20G x 1"	BD	22,900 €	21
212	25 x 1.2	18G x 1"	BD	14,550 €	21
226	38 x 1.2	18G x 1 1/2"	BD	14,550 €	21
210	25 x 1.2	18G x 1"	Vacurette	13,980 €	21
216	38 x 1.2	18G x 1 1/2"	Vacurette	13,980 €	21



213

Portatubos

Ref.	Marca	PVP	IVA
280	BD	0,095 €	21
281	Vacurette	0,095 €	21



Gradillas

Ref.	Capac.	Material	PVP	IVA
203 *	60 x 0,5-1,5 ml	Plástico	5,150 €	21
201	50 x 5 ml	Aluminio	11,450 €	21
207	50 x 12 ml	Aluminio	12,950 €	21
208	24 x 30 ml	Plástico	17,950 €	21



201



208



203

* para pipetas Eppendorf

Catéter intravenoso

- Caja de 50 uds

Ref.	Medida	Color	Gauge	PVP	IVA
0100	19 x 0.70	Amarillo	24G x 3/4"	33,950 €	21
0103	25 x 0.85	Azul	22G x 1"	33,950 €	21
0105	32 x 1.10	Rosa	20G x 1 1/4"	33,950 €	21
0107	50 x 1.10	Rosa	20G x 2"	33,950 €	21
0110	50 x 1.35	Verde	18G x 2"	33,950 €	21
0109	50 x 1.70	Gris	16G x 2"	33,950 €	21
0111	50 x 2.20	Naranja	14G x 2"	33,950 €	21
0113	63 x 1.70	Gris	16G x 2 1/2"	33,950 €	21



Catéter intravenoso de mariposa

Ref.	Medida	Color	Gauge	PVP	IVA
13660	19 x 1.1	Crema	19G	0,380 €	21
13662	19 x 0.8	Verde	21G	0,380 €	21
13664	19 x 0.6	Azul	23G	0,380 €	21



Catéter intravenoso Venocan

- Caja de 50 uds

Ref.	Medida	Color	Gauge	PVP	IVA
13670	19 x 0.7	Amarillo	24G	46,950 €	21
13672	25 x 0.9	Azul	22G	46,950 €	21
13674	33 x 1.1	Rosa	20G	46,950 €	21
13676	45 x 1.3	Verde	18G	46,950 €	21
13678	50 x 1.7	Gris	16G	46,950 €	21
13680	50 x 2.1	Naranja	14G	46,950 €	21



Catéter urinario Foley

Ref.	Ø	PVP	IVA
13601	20	3,150 €	21
13602	24	3,150 €	21
13603	30	3,150 €	21



Sets para frasco / Aguja flotante

Ref.	Ø	Desc.	PVP	IVA
260	-	Aguja flotante	7,850 €	21
270/50	20 mm	50/100 ml	4,150 €	21
270/250	30 mm	250/500 ml	4,150 €	21
270/500	33 mm	≥ 500 ml	4,150 €	21



Gotero terneros

- Regulador de caudal con rueda y filtro de aire obturable
- Calibración: 20 gotas/ml
- Tubo de PVC extra largo de 250 cm
- 2 sitios de inyección a 25 y 95 cm respectivamente del conector L/L
- Corte-flujo instantáneo

Ref.	Cono	PVP	IVA
373	Luer Lock	2,950 €	21



Gotero vacuno

- Calibración: 20 gotas/ml
- Tubo de PVC largo de 162 cm

Ref.	Cono	PVP	IVA
370	Luer Lock	0,629 €	21
371	Roller	0,629 €	21



Gotero caballos

- Suministra hasta 25 litros/hora

Ref.	PVP	IVA
375	45,950 €	21



Bolsa de transfusión CPDA

Ref.	Capac.	Cant.	PVP	IVA
296	450 ml	10	48,400 €	21
380	500 ml	1	8,890 €	21



Conector gotero 3 vías

Ref.	PVP	IVA
374	0,890 €	21



Alargador gotero

Ref.	Long.	PVP	IVA
372	100 cm	0,590 €	21



Sonda uretral para perros

Ref.	Medidas	Dureza	Color	PVP	IVA
13610	2 x 500 mm	Blanda	Blanca	3,950 €	21
13612	2,6 x 500 mm	Blanda	Rosa	3,950 €	21
13614	3,3 x 500 mm	Blanda	Azul	3,950 €	21
13616	2 x 500 mm	Semirígida	Blanca	3,950 €	21
13618	2,6 x 500 mm	Semirígida	Rosa	3,950 €	21
13620	3,3 x 500 mm	Semirígida	Azul	3,950 €	21



Sonda uretral "Tiemann" para perras

Ref.	Medidas	Dureza	PVP	IVA
13630	2,6 x 390 mm	Semirígida	6,950 €	21
13632	3,3 x 390 mm	Semirígida	6,950 €	21



Sonda uretral "Arnold" para perros y gatos

Ref.	Medidas	Color	PVP	IVA
13640	1 x 300 mm	Rosa	9,950 €	21
13645	1,3 x 300 mm	Blanca	9,950 €	21



Sonda uretral "Buster" para gatos

- Caja de 12 uds

Ref.	Medidas	Fiador	PVP	IVA
13650	1x 130 mm	No	35,950 €	21
13655	1,3 x 130 mm	No	39,950 €	21
13652	1 x 130 mm	Sí	50,950 €	21
13658	1,3 x 130 mm	Sí	55,950 €	21



Sonda uretral caballos

Ref.	Medidas	PVP	IVA
6460	1.350 x 6,5 mm	19,900 €	21



Desinfectantes

Ref.	Descripción	Capac.	PVP	IVA
242	Agua oxigenada	250 ml	0,710 €	21
244	Agua oxigenada	500 ml	0,980 €	21
246	Agua oxigenada	1.000 ml	1,390 €	21
266	Alcohol 96°	250 ml	0,980 €	21
267	Alcohol 96°	500 ml	1,850 €	21
268	Alcohol 96°	1.000 ml	2,950 €	21
270	Povidona iodada	450 ml	6,490 €	21
272	Povidona iodada	1.000 ml	8,490 €	21
206/1L	Gel hidroalcohólico	1.000 ml	9,680 €	21
206/5L	Gel hidroalcohólico	5.000 ml	45,900 €	21



Esparadrado de tela

- Color carne

Ref.	Medidas	PVP	IVA
200	2,5 cm x 5 m	1,240 €	10
202	5 cm x 5 m	2,290 €	10
204	10 cm x 10 m	7,950 €	10



Algodón

Ref.	Peso	PVP	IVA
217	250 gr	2,290 €	10
218	500 gr	3,980 €	10
219	1.000 gr	7,690 €	10



Apósito de gasa

- 8 capas

Ref.	Medidas	Cant.	Modelo	PVP	IVA
256	16 x 25 cm	5	Estéril	0,170 €	10
257	20 x 20 cm	10	Estéril	0,290 €	10
233	20 x 20 cm	2.500	No estéril	38,890 €	10



Venda de gasa

Ref.	Medidas	PVP	IVA
231	10 cm x 10 m	0,415 €	10
232	20 cm x 10 m	0,990 €	10



Venda cambric

Ref.	Medidas	PVP	IVA
235	10 cm x 10 m	0,970 €	10



Venda de crepé

Ref.	Medidas	PVP	IVA
211	10 cm x 10 m	0,990 €	10



Venda de fibra de vidrio CellCast Xtra

- Fibra de vidrio con resina de poliuretano
- Muy ligeros y alta estabilidad
- Permeable al aire, transparente a rayos X
- Impermeable una vez fraguado

Ref.	Medidas	PVP	IVA
3462	7,5 cm x 3,6 m	8,950 €	10
3464	12,5 cm x 3,6 m	13,950 €	10



Venda de yeso

Ref.	Medidas	Cant.	PVP	IVA
251	5 cm x 2,7 m	2	1,950 €	10
252	10 cm x 2,7 m	2	2,890 €	10
253	15 cm x 2,7 m	2	3,950 €	10
254	20 cm x 2,7 m	2	4,950 €	10



Venda para almohadillado

- Perfecta para aislar y amortiguar el vendaje de escayola
- Sintética hipoalergénica: 90% Fibra poliéster + 10% Fibra autoligante
- Transparente a los rayos X

Ref.	Medidas	PVP	IVA
249/5	5 cm x 2,75 m	0,293 €	10
249/7.5	7,5 cm x 2,75 m	0,464 €	10
249/10	10 cm x 2,75 m	0,571 €	10
249/15	15 cm x 2,75 m	0,903 €	10
249/20	20 cm x 2,75 m	1,294 €	10



Venda Tensoplast

- Elástica, porosa y adhesiva

Ref.	Medidas	PVP	IVA
3450	7,5 cm x 4,5 m	8,950 €	10



Venda Self-fix

- Elástica, porosa y adhesiva

Ref.	Medidas	PVP	IVA
3431	10 cm x 4 m	1,390 €	10



Venda Teat-Bandage

- Específica para ubres de vacas
- Cohesiva, de poliéster
- Aplicable con humedad

Ref.	Medidas	PVP	IVA
3440	6 cm x 4,5 m	8,650 €	10



Venda Soft-Flex

- Cohesiva, de poliéster
- No se adhiere a la piel
- Aplicable con humedad

Ref.	Medidas	PVP	IVA
3430	9 cm x 5 m	24,500 €	10



Venda Smarch

- Látex

Ref.	Medidas	PVP	IVA
3455	10 cm x 10 m	44,95 €	10



Venda cohesiva Vet-Flex

- Elástica y autoadhesiva

Ref.	Medidas	Color	Cant.	PVP	IVA
3310/R	5 cm x 4,5 m	Rojo	10	15,950 €	10
3320/BL	7,5 cm x 4,5 m	Blanco	10	19,950 €	10
3320/V	7,5 cm x 4,5 m	Verde	10	19,950 €	10
3330/BL	10 cm x 4,5 m	Blanco	10	23,950 €	10
3330/R	10 cm x 4,5 m	Rojo	10	23,950 €	10
3330/V	10 cm x 4,5 m	Verde	10	23,950 €	10
3330/AZ	10 cm x 4,5 m	Azul	10	23,950 €	10
3330/AM	10 cm x 4,5 m	Amarillo	10	23,950 €	10
3330/N	10 cm x 4,5 m	Negro	10	23,950 €	10



Venda cohesiva Veter-Flex

- Elástica y autoadhesiva
- Económica

Ref.	Medidas	Color	Cant.	PVP	IVA
3360/BL	5 cm x 4,5 m	Blanco	10	13,500 €	10
3360/V	5 cm x 4,5 m	Verde	10	13,500 €	10
3370/BL	7,5 cm x 4,5 m	Blanco	10	15,500 €	10
3370/V	7,5 cm x 4,5 m	Verde	10	15,500 €	10
3380/BL	10 cm x 4,5 m	Blanco	10	18,750 €	10
3380/V	10 cm x 4,5 m	Verde	10	18,750 €	10
3380/R	10 cm x 4,5 m	Rojo	10	18,750 €	10
3380/AZ	10 cm x 4,5 m	Azul	10	18,750 €	10
3380/N	10 cm x 4,5 m	Negro	10	18,750 €	10



Venda cohesiva Vet-Plast

- Elástica, porosa y autoadhesiva

Ref.	Medidas	Color	Cant.	PVP	IVA
3410	5 cm x 4,5 m	Blanco	10	69,950 €	10
3415	7,5 cm x 4,5 m	Blanco	10	75,950 €	10
3420	10 cm x 4,5 m	Blanco	10	93,950 €	10



Bote de recogida de muestras

- Fabricados en polipropileno transparente
- Tapón en color rojo, con cierre de alta seguridad hermético
- Envasados en bolsas individuales

Ref.	Capac.	Graduado	PVP	IVA
292	60 ml	No	0,189 €	21
293	100 ml	Sí	0,189 €	21
294/200	200 ml	Sí	0,439 €	21



Bote de recogida de muestras

- Fabricados en polietileno de alta densidad translúcido
- Boca ancha , tapa a rosca de color negro y obturador

Ref.	Capac.	Graduado	PVP	IVA
294	250 ml	No	0,990 €	21
294/500	500 ml	No	2,300 €	21



Botella con tapón precinto

- Fabricadas en polietileno alta densidad translúcido
- Tapón precinto en color rojo, con ranuras para facilitar el uso con guantes
- Botellas herméticas, se suministran sin roscar
- Recipientes inviolables gracias a su anillo-precinto
- Para cerrarlas, roscar el frasco y dar un nuevo giro, actuando entonces el precinto
- Al desenroscar, se rompe automáticamente el anillo-precinto, que quedará en el cuerpo del frasco

Ref.	Capac.	Graduado	PVP	IVA
273	1.000 ml	No	1,390 €	21



Botella con asa

- Cuerpo y tapón fabricados en polietileno de alta densidad
- Ideal para recogida de muestras de orina de 24 horas y muestras de líquidos

Ref.	Capac.	Graduado	PVP	IVA
271	2.000 ml	Sí	1,690 €	21



Botella para mezclas

- Tapón con goma interior para cierre hermético

Ref.	Capac.	Graduado	PVP	IVA
277/250	250 ml	No	1,890 €	21
277/500	500 ml	No	1,990 €	21
277	1.000 ml	No	2,100 €	21



Pipetas de plástico Pasteur

- Polietileno transparente e inerte
- Tolerancia volumétrica $\pm 10\%$

Ref.	Capac.	Graduado	Cant.	PVP	IVA
285	1 ml	No	500	19,990 €	21



Microtubo Eppendorf

- Polipropileno transparente autoclavable
- Tapón unido a tubo
- Resistencia centrifugación: 15.000 rpm, congelables hasta -100°C

Ref.	Capac.	Graduado	Cant.	PVP	IVA
279/500	1,5 ml	No	500	9,500 €	21



Hisopo estéril

- Escobillones en tubo de polipropileno
- Fondo redondo con etiqueta para precinto

Ref.	Conservante	PVP	IVA
216/C	Amies	0,450 €	21
216/S	Sin	0,221 €	21



Escobillones

Ref.	Longitud	Cant.	Modelo	PVP	IVA
223	15 cm	100	Estéril	10,900 €	21
222	15 cm	100	No estéril	1,790 €	21



Cuchara de recogida de muestras

Ref.	Longitud	Uso	PVP	IVA
13270	22 cm	Vacuno	0,785 €	21
13272	21 cm	Ovino - caprino	0,775 €	21



Contenedor de seguridad

- Aptos para material desechable
- Fabricado en polietileno de alta densidad, color amarillo
- Totalmente incinerables, sin restos de residuos

Ref.	Capac.	Residuos	Autoclave	PVP	IVA
13533	1 L	III	No	1,980 €	21
13535	6 L	II + III	Sí	6,950 €	21
13537	20 L	II + III	No	15,850 €	21



Jeringa Sodistar

Ref.	Capac.	PVP	IVA
360	20 cc	0,950€	21



Jeringa de plástico

Ref.	Capac.	Cono	Dosific.	PVP	IVA
400	5 cc	Luer Lock	No	3,950 €	21
405	10 cc	Luer Lock	No	3,300 €	21
410	20 cc	Luer Lock	No	3,650 €	21
415	30 cc	Luer Lock	No	4,150 €	21
420	50 cc	Luer Lock	No	4,650 €	21
438	100 cc	Luer Lock	No	8,950 €	21



Jeringa de plástico Agriplast

Ref.	Capac.	Cono	Dosific.	PVP	IVA
405/A	10 cc	Luer Lock	No	3,300 €	21
410/A	20 cc	Luer Lock	No	3,650 €	21
415/A	30 cc	Luer Lock	No	4,150 €	21
420/A	50 cc	Luer Lock	No	4,650 €	21



Jeringa de plástico con dosificador

Ref.	Capac.	Cono	Dosific.	PVP	IVA
482	5 cc	Luer Lock	Si	9,850 €	21
483	10 cc	Luer Lock	Si	3,890 €	21
484	20 cc	Luer Lock	Si	4,150 €	21
495	30 cc	Luer Lock	Si	4,950 €	21
496	50 cc	Luer Lock	Si	5,950 €	21



Jeringa de plástico

- Émbolo de metal

Ref.	Capac.	Cono	Dosific.	PVP	IVA
435	10 cc	Luer Lock	No	7,250 €	21
440	20 cc	Luer Lock	No	7,950 €	21
445	30 cc	Luer Lock	No	8,350 €	21
450	50 cc	Luer Lock	No	8,950 €	21



Jeringa de metal

Ref.	Capac.	Dosific.	PVP	IVA
465	20 cc	Si	11,950 €	21
470	50 cc	Si	14,950 €	21
472	100 cc	Si	29,950 €	21



Jeringa dosificadora azul

Ref.	Capac.	PVP	IVA
555	35 cc	24,950 €	21
556	70 cc	22,900 €	21
557	200 cc	24,950 €	21
558	300 cc	28,950 €	21
559	500 cc	59,950 €	21



Jeringa dosificadora azul con tubo de goma

Ref.	Capac.	PVP	IVA
562	50 cc	39,850 €	21
560	70 cc	42,950 €	21



Jeringa dosificadora Genia Pistolman

Ref.	Capac.	PVP	IVA
510	20 cc	24,850 €	21
520	50 cc	26,950 €	21
530	70 cc	28,550 €	21
540	150 cc	34,500 €	21
550	250 cc	35,950 €	21



Jeringa dosificadora Genia Syrman

Ref.	Capac.	PVP	IVA
610	300 cc	26,550 €	21
615	450 cc	30,850 €	21



Jeringa inyectable Genia Syrman

Ref.	Capac.	Cono	PVP	IVA
620	300 cc	Luer Lock	28,950 €	21
625	450 cc	Luer Lock	34,950 €	21



Cánulas dosificadoras

Ref.	Long.	Cono	PVP	IVA
430*	19 cm	Rosca	3,950 €	21
475	19 cm	Luer Lock	3,950 €	21
480	12 cm	Luer Lock	2,950 €	21



* (Adaptable a todas las jeringas de plástico)

Jeringa dosificadora Master Line V-Grip

Ref.	Capac.	PVP	IVA
1115	75 cc	53,850 €	21
1115/03	Boquilla Pour-on	10,550 €	21



Jeringa dosificadora metálica NJ Phillips con mochila

- Mochila de 2,5 L incluida

Ref.	Capac.	PVP	IVA
650	30 cc	125,950 €	21
655	60 cc	132,950 €	21



Jeringa dosificadora plástico NJ Phillips

- Tubo absorción incluido

Ref.	Capac.	PVP	IVA
658	25 cc	38,950 €	21



Gancho dosificadoras NJ Phillips

Ref.	Medidas	PVP	IVA
654	Gancho 45 cm + Tubo 100 cm	79,950 €	21



Mochila dosificadoras NJ Phillips

Ref.	Capac.	PVP	IVA
656	2,5 L	26,950 €	21



Jeringa dosificadora Diamant metálica con mochila

- Mochila de 5 L
- Convertible a inyectable con solo cambiar la cánula por el rácor

Ref.	Capac.	Modelo	Mochila	PVP	IVA
DI700	30 cc	Dosificadora	Si	56,900 €	21
DI700/SM	30 cc	Dosificadora	No	48,750 €	21
DI700/I	30 cc	Inyectable	Si	56,900 €	21
DI710	60 cc	Dosificadora	Si	77,950 €	21
DI710/SM	60 cc	Dosificadora	No	69,750 €	21
DI710/I	60 cc	Inyectable	Si	77,950 €	21



Jeringa dosificadora Diamant plástico con mochila

- Mochila de 5 L
- Convertible a inyectable con solo cambiar la cánula por el rácor

Ref.	Capac.	Modelo	Mochila	PVP	IVA
DI565	30 cc	Dosificadora	Si	42,950 €	21
DI565/SM	30 cc	Dosificadora	No	33,950 €	21
DI565/I	30 cc	Inyectable	Si	42,950 €	21
DI565/ISM	30 cc	Inyectable	No	33,950 €	21

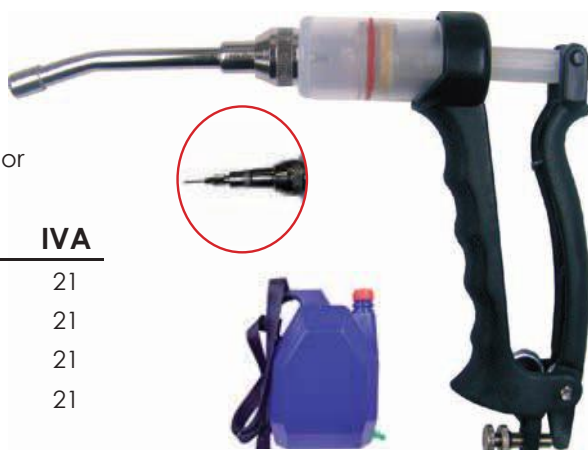

Gancho dosificadoras Diamant

Ref.	Jeringa	Medidas	PVP	IVA
DI715	30 cc	Gancho 55 cm + Tubo 100 cm	39,900 €	21
DI718	60 cc	Gancho 55 cm + Tubo 100 cm	39,900 €	21



Mochila dosificadoras Diamant

Ref.	Capac.	PVP	IVA
DI730	5 L	11,900 €	21



Jeringa revolver Roux

- Cilindro de cristal
- Cono Luer Lock



Ref.	Capac.	Dosificación	PVP	IVA
900	10 cc	0,25 / 0,50 / 0,75 / 1 cc	49,950 €	21
910	30 cc	1 / 2 / 3 / 4 / 5 cc	47,950 €	21
920	50 cc	1 / 2 / 3 / 4 / 5 cc	44,950 €	21

Jeringa revolver Roux con alargador 40cm

- Cilindro de cristal
- Cono Luer Lock



Ref.	Capac.	Dosificación	PVP	IVA
940	50 cc	1 / 2 / 3 / 4 / 5 cc	95,850 €	21

Alargadores Roux para jeringas revolver

Ref.	Long.	Dureza	Cono	PVP	IVA
943	29 cm	Semirígido	Luer / Luer	48,950 €	21
944	29 cm	Semirígido	Rosca / Luer	48,950 €	21
945	40,5 cm	Rígido	Rosca / Luer	51,950 €	21
900/40	Cono rosca Roux 10 cc			8,900 €	21
920/40	Cono rosca Roux 30 - 50 cc			6,900 €	21



Jeringa revolver NJ Phillips

- Cilindro de plástico
- Cono Luer Lock



Ref.	Capac.	Dosificación	PVP	IVA
1055	25 cc	0,5 / 1 / 1,5 / 2 / 2,5 cc	93,850 €	21
1060	50 cc	1 / 2 / 3 / 4 / 5 cc	90,850 €	21

Jeringa revolver Hauptner Muto

- Cilindro de cristal
- Cono Luer Lock

Ref.	Capac.	Dosificación	PVP	IVA
1010	10 cc	0,25 / 0,50 / 0,75 / 1 cc	92,850 €	21
1020	25 cc	0,50 / 1 / 1,50 / 2 / 2,50 cc	90,950 €	21
1030	30 cc	1 / 2 / 3 / 4 / 5 cc	79,950 €	21
1040	50 cc	1 / 2 / 3 / 4 / 5 cc	71,950 €	21



Alargadores Hauptner para jeringas revolver

- Incluyen cono Luer Lock y cono rosca alargador

Ref.	Long.	Dureza	PVP	IVA
1045	40 cm	Semirígido	66,950 €	21
1049	50 cm	Semirígido	72,950 €	21
1047	70 cm	Rígido	74,950 €	21

ALARGADORES ORIGINALES HAUPTNER

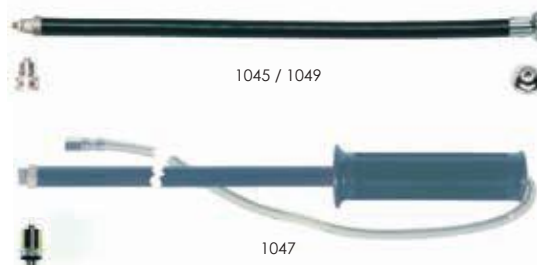

Jeringa revolver Diamant

- Cilindro de plástico
- Cono Luer Lock

Ref.	Capac.	Dosificación	PVP	IVA
DI810	50 cc	1 / 2 / 3 / 4 / 5 cc	32,950 €	21



Alargadores semirígido Diamant para jeringas revolver

Ref.	Compatible	Long.	PVP	IVA
DI815/DE	Diamant / Europlex	40 cm	36,900 €	21
DI815/HR	Hauptner / Roux	40 cm	36,900 €	21



Jeringa revolver Henke Multi-Matic

- Cilindro de plástico
- Cono Luer Lock

Ref.	Capac.	Dosificación	PVP	IVA
1251	25 cc	0,5 / 1 / 1,5 / 2 / 2,5 cc	75,850 €	21
1253	50 cc	1 / 2 / 3 / 4 / 5 cc	73,850 €	



Sistema automático de esterilización de agujas Sterimatic

- Kit preparado para usar con jeringas Hauptner Muto
- Incluye 5 tapones, portataponos, cono L/L y cono doble rosca

Ref.	Descripción	PVP	IVA
1485	Kit completo	46,990 €	21
1485/S	Porta tapones	11,950 €	21
1485/T	Tapones (5 uds)	19,950 €	21



Jeringa vacunador Socorex

- Aguja de ascensión y tubo de goma
- Cono Luer Lock

Ref.	Capac.	Dosificación	PVP	IVA
1407	0,3 cc	0,1 / 0,2 / 0,3	91,850 €	21
1410	0,5 cc	0,1 / 0,2 / 0,3 / 0,4 / 0,5 cc	79,950 €	21
1420	1 cc	0,1 / 0,2 / ... / 0,9 / 1 cc	79,950 €	21
1430	2 cc	0,1 / 0,2 / ... / 1,9 / 2 cc	79,950 €	21
1440	5 cc	0,5 / 1 / 1,5 / ... / 4,5 / 5 cc	86,950 €	21
1450	10 cc	1 / 2 / 3 / ... / 9 / 10 cc	99,950 €	21



Jeringa vacunador Socorex doble

- Agujas de ascensión x2 y tubos de goma x2
- Cono Luer Lock

Ref.	Capac.	Dosificación	PVP	IVA
1340	0,5 cc	0,1 / 0,2 / 0,3 / 0,4 / 0,5 cc	189,950 €	21
1343	1 cc	0,1 / 0,2 / ... / 0,9 / 1 cc	192,950 €	21
1345	2 cc	0,1 / 0,2 / ... / 1,9 / 2 cc	192,950 €	21
1350	5 cc	0,5 / 1 / 1,5 / ... / 4,5 / 5 cc	199,950 €	21



Jeringa vacunador Henke Vet-Matic

- Aguja de ascensión y tubo de goma
- Cono Luer Lock

Ref.	Capac.	Dosificación	PVP	IVA
1210	5 cc	0,5 / 1 / ... / 4,5 / 5 cc	64,900 €	21
1220	10 cc	0,5 / 1 / ... / 9,5 / 10 cc	89,900 €	21



Jeringa vacunador NJ Phillips

- Tubo de goma

Ref.	Capac.	Dosificación	PVP	IVA
1065	5 cc	0,5 / 1 / ... / 4,5 / 5 cc	79,900 €	21



Jeringa vacunador Hauptner Muto Express II

- Aguja de ascensión y tubo de goma
- Cono rosca

Ref.	Capac.	Dosificación	PVP	IVA
1005	5 cc	0,5 / 1 / 2 / 3 / 4 / 5 cc	220,900 €	21



Jeringa vacunador Master Line

- Aguja de ascensión y tubo de goma
- Cono Luer Lock

Ref.	Capac.	Dosificación	PVP	IVA
1120	0,5 cc	0,1 / 0,2 / 0,3 / 0,4 / 0,5 cc	48,850 €	21
1125	1 cc	0,1 / 0,2 / ... / 0,9 / 1 cc	48,850 €	21
1130	2 cc	0,1 / 0,2 / ... / 1,9 / 2 cc	48,850 €	21



Jeringa vacunador Serena S05T / S1T / S2T

- Tubo de goma y aguja de aspiración
- Cono Luer Lock

Ref.	Capac.	Dosificación	PVP	IVA
1413	0,5 cc	0,05 - 0,5 cc	42,950 €	21
1414	1 cc	0,1 - 1 cc	44,950 €	21
1415	2 cc	0,2 - 2 cc	51,950 €	21



Jeringa vacunador Serena S5T / S12T

- Tubo de goma y aguja de aspiración
- Cono Luer Lock

Ref.	Capac.	Dosificación	PVP	IVA
1416	5 cc	1 - 5 cc	56,950 €	21
1417	12 cc	2 - 12 cc	72,950 €	21
1416/CAN	Cánula de repuesto		3,250 €	21



Jeringa vacunador Serena STPAC con alargador de 50 cm

- Tubo de goma y aguja de aspiración
- Cono Luer Lock

Ref.	Capac.	Dosificación	PVP	IVA
1455	5 cc	1 - 5 cc	199,950 €	21
1457	12 cc	2 - 12 cc	209,950 €	21



Jeringa vacunador Henke Eco-Matic

- Tubo de goma
- Cono Luer Lock

Ref.	Capac.	Dosificación	PVP	IVA
1240	2 cc	0,1 / 0,2 / ... / 1,9 / 2 cc	24,950 €	21
1242	5 cc	0,5 / 1 / ... / 4,5 / 5 cc	24,950 €	21



Jeringa vacunador Henke Eco-Matic

- 3 adaptadores incluidos: 100 cc (blanco) / 250 cc (azul) / 500 cc (verde)
- Cono Luer Lock

Ref.	Capac.	Dosificación	PVP	IVA
1260	0,3 cc	0,1 / 0,3 cc	35,950 €	21
1261	1 cc	0,5 / 1 cc	35,950 €	21
1262	2 cc	0,1 / 0,2 / ... / 1,9 / 2 cc	29,950 €	21
1265	5 cc	0,5 / 1 / ... / 4,5 / 5 cc	29,950 €	21
1201	Adaptador 100 cc Ø 20 mm (blanco)		3,500 €	21
1202	Adaptador 250 cc Ø 30 mm (azul)		3,500 €	21
1203	Adaptador 500 cc Ø 33 mm (verde)		3,500 €	21



Jeringa vacunador Henke Eco-Matic

- Portafrascos 100 cc
- Cono Luer Lock

Ref.	Capac.	Dosificación	PVP	IVA
1254	0,3 cc	0,05 / 0,1 / ... / 0,25 / 0,3 cc	32,650 €	21
1258	1 cc	0,1 / 0,2 / ... / 0,9 / 1 cc	31,950 €	21
1255	2 cc	0,1 / 0,2 / ... / 1,9 / 2 cc	24,950 €	21
1257	5 cc	0,5 / 1 / ... / 4,5 / 5 cc	24,950 €	21
1259	Adaptador para frascos 250 ml		12,600 €	21



Jeringa vacunador Henke Eco-Matic

- Adaptador para botellas (botella no incluida)
- Cono Luer Lock

Ref.	Capac.	Dosificación	PVP	IVA
1270	2 cc	0,1 / 0,2 / ... / 1,9 / 2 cc	32,950 €	21
1271	5 cc	0,5 / 1 / ... / 4,5 / 5 cc	32,950 €	21
1273	Botella plástico 250 ml		6,950 €	21



1273

Jeringa vacunador Henke Ferro-Matic

- Portafrascos de Ø20 mm y de Ø30 mm
- Cono Luer Lock

Ref.	Capac.	Dosificación	PVP	IVA
1303	3 cc	0,2 / 0,4 / ... / 2,8 / 3 cc	94,950 €	21
1305	5 cc	0,5 / 1 / ... / 4,5 / 5 cc	94,950 €	21



Jeringa vacunador Socorex

- Portafrascos incluido
- Cono Luer Lock

Ref.	Capac.	Dosificación	PVP	IVA
1465	0,5 cc	0,1 / 0,2 / 0,3 / 0,4 / 0,5 cc	84,950 €	21
1467	1 cc	0,1 / 0,2 / ... / 0,9 / 1 cc	84,950 €	21
1469	2 cc	0,1 / 0,2 / ... / 1,9 / 2 cc	89,950 €	21
1471	5 cc	0,5 / 1 / 1,5 / ... / 4,5 / 5 cc	95,950 €	21
1473	10 cc	1 / 2 / 3 / ... / 9 / 10 cc	106,950 €	21



Alargadores Socorex

- Compatibles con jeringas Henke Vet-Matic

Ref.	Long.	Dureza	Cono	PVP	IVA
1358	20 cm	Rígido	Luer / Luer	63,950 €	21
1361	30 cm	Rígido	Luer / Luer	63,950 €	21



Accesorios Socorex

Ref.	Descripción	PVP	IVA
1476	Adaptador frascos 100 cc	35,950 €	21
1401	Botella Socorex 60 cc * (usar con 1460)	32,950 €	21
1460	Cono doble rosca Socorex	18,900 €	21



1476



1401



1460

Vacunador Pump-It

Ref.	Capac.	Frasco	Ø Boca	PVP	IVA
1272	2 cc	60 cc	4,5 cm	20,950 €	21
1275	2 cc	120 cc	5,4 cm	20,950 €	21
1277	5 cc	120 cc	5,4 cm	20,950 €	21



1272

1275 / 1277

Jeringa vacunador Serena S05TPF / S1TPF / S2TPF

- Portafrascos
- Cono Luer Lock

Ref.	Capac.	Dosificación	PVP	IVA
1408	0,5 cc	0,05 - 0,5 cc	63,900 €	21
1409	1 cc	0,1 - 1 cc	65,900 €	21
1418	2 cc	0,1 - 2 cc	67,900 €	21



Jeringa vacunador Serena S5TPF

- Portafrascos
- Cono Luer Lock

Ref.	Capac.	Dosificación	PVP	IVA
1419	5 cc	1 - 5 cc	89,950 €	21



Jeringa vacunador Serena S2TC250

- Botella 250 cc x2
- Cono Luer Lock

Ref.	Capac.	Dosificación	PVP	IVA
1456	2 cc	0,1 - 2 cc	82,900 €	21



Jeringa vacunador Serena SV para viruela avícola

- Permite mantener la vacuna más limpia
- Disolver 3ml de vacuna en el cilindro para 1.000 dosis

Ref.	Capac.	Dosificación	PVP	IVA
1406	3 cc	0,003 cc	72,950 €	21



Jeringa vacunador Master Line

- Portafrascos
- Cono Luer Lock

Ref.	Capac.	Dosificación	PVP	IVA
1101	0,5 cc	0,1 / 0,2 / 0,3 / 0,4 / 0,5 cc	44,950 €	21
1105	1 cc	0,1 / 0,2 / ... / 0,9 / 1 cc	44,950 €	21
1110	2 cc	0,1 / 0,2 / ... / 1,9 / 2 cc	44,950 €	21
1155	Portafrascos 100 ml		2,300 €	21
1157/23	Portafrascos 250 ml (EU)		0,990 €	21
1157/33	Portafrascos 250 ml (USA)		0,990 €	21
1159	Portafrascos 100 ml		3,990 €	21



Jeringa vacunador tuberculina Hauptner Muto

- Cilindro de plástico
- Cono Luer Lock
- Apta para autoclave (esterilización a 134°)

Ref.	Capac.	Dosificación	PVP	IVA
1070	5 cc	0,1 / 0,2 / 0,3 / 0,4 cc	194,890 €	21



Jeringa vacunador tuberculina Henke Ject-TBC

- Cilindro de cristal
- Cono Luer Lock
- Apta para autoclave (esterilización a 134°)

Ref.	Capac.	Dosificación	PVP	IVA
1150	2 cc	0,1 / 0,2 / ... / 0,9 / 1 cc	189,900 €	21



Aguja de tuberculina

- Cono Luer Lock

Ref.	Medidas	Cant.	Calid.	PVP	IVA
1152/H	0,7 x 4 mm *	1	Henke	3,950 €	21
1152/G	0,7 x 4 mm	1	A	5,990 €	21
1151/B	0,7 x 4 mm	12	A	49,950 €	21



Inyector intradérmico DermoJet

- Capacidad de carga de 40 disparos de 0,1cc
- Indoloro, inyecta sin aguja

Ref.	Capac.	Dosific.	PVP	IVA
1490	4 cc	0,1cc	489,950 €	21

Insprovet cuenta con un servicio técnico propio, entrenado y autorizado por el fabricante para expedir certificados de reparación y calibración, para ello utilizamos solamente recambios originales.



Garrocha nylon

- Cilindro de plástico

Ref.	Capac.	Dosific.	PVP	IVA
1195	26 cc	1cc	189,950 €	21



Aguja de garrocha

- Cono rosca

Ref.	Medidas	Cant.	Garrocha	PVP	IVA
1174	20 x 3.0	1	Nylon	6,950 €	21
1176	25 x 3.0	1	Nylon	6,950 €	21
DI1170	30 x 2.5	1	Diamant	4,950 €	21



1174 - 1176



DI1170

Alargador metálico mango madera para garrocha

Ref.	Long.	Modelo	PVP	IVA
DI1162	3 m	Diamant	39,950 €	21
1195/MB	1,79 > 2,8 m	Bellota	39,950 €	21



DI1162



1195/MB

Portafrascos

Ref.	Modelo	Capac.	PVP	IVA
1143	Brazo	50 - 100 cc	14,900 €	21
1145	Brazo	250 cc	16,750 €	21
1148	Brazo	500 - 1.000 cc	19,950 €	21
1139	Cintura / Bandolera	250 cc	17,950 €	21
1141	Cintura / Bandolera	500 - 1.000 cc	19,950 €	21



1139 - 1141



1143 - 1145 - 1148

Pistolas de limpieza

Ref.	Color	Boquilla	PVP	IVA
1438	Rojo	Metal	12,550 €	21
1439	Verde	PVC	10,950 €	21



Filtro para leche "Sana"

Ref.	Ø	Cant.	PVP	IVA
1491	160 mm	200	5,850 €	21
1492	180 mm	200	6,850 €	21
1498	200 mm	200	7,850 €	21
1494	220 mm	200	8,250 €	21
1497	240 mm	200	9,550 €	21



Filtro para tubo

Ref.	Long.	Ancho	Cant.	PVP	IVA
1421	250 mm	57/60 mm	250	17,950 €	21
1422	320 mm	57/60 mm	250	20,950 €	21
1423	455 mm	57/60 mm	250	26,950 €	21
1424	500 mm	57/60 mm	250	30,950 €	21
1425	530 mm	57/60 mm	250	32,950 €	21
1426	620 mm	57/60 mm	250	34,950 €	21
1434	820 mm	75/78 mm	250	64,950 €	21



Esponja de limpieza para tubo

Ref.	Long.	Ø	Cant.	PVP	IVA
1427	70 mm	40 mm	10	5,950 €	21
1428	70 mm	50 mm	10	6,450 €	21
1429	70 mm	60 mm	10	7,450 €	21
1429/70	80 mm	70 mm	10	10,950 €	21



Tubo para leche

Ref.	Cant.	Long.	Ø	Material	PVP	IVA
1431	4	180 mm	8,5 x 16 mm	Simple	4,580 €	21
1432	4	150 mm	8,0 x 16 mm	Reforzado	6,570 €	21
1433	4	180 mm	8,5 x 16 mm	Reforzado	7,680 €	21



1431



1432



1433

Tubo para aire

Ref.	Cant.	Long.	Ø	PVP	IVA
1435	4	200 mm	7 x 13,5 mm	3,290 €	21
1436	4	230 mm	7 x 13,5 mm	3,890 €	21



Cubo galvanizado

Ref.	Capac.	PVP	IVA
2083	9 L	8,890 €	21
2085	14 L	10,290 €	21



Cepillo de limpieza para pezonera

Ref.	Long.	Mango	PVP	IVA
1481	50 cm	Madera	4,580 €	21
1481/P	42 cm	Plástico	6,950 €	21

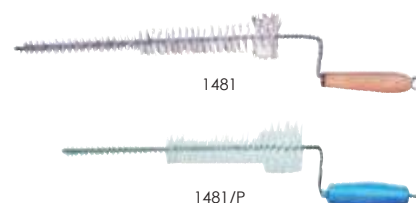

Cepillo de limpieza para tubo de leche

Ref.	Long.	PVP	IVA
1441	140 cm	3,950 €	21
1442	30 cm	1,250 €	21



Cepillo de limpieza para lechera

Ref.	Long.	Material	PVP	IVA
1483	40 cm	Plástico	13,950 €	21
1484	40 cm	Madera	5,950 €	21



Batidor

Ref.	Long.	Material	PVP	IVA
2055	40 cm	Madera	6,950 €	21
2055/A	40 cm	Acero	9,950 €	21

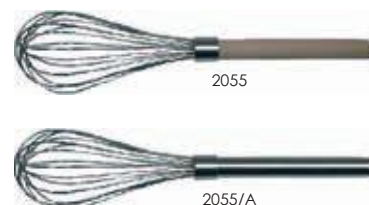

Jarra comprobación para leche

Ref.	Capac.	Modelo	PVP	IVA
2001	1 L	Tapa	2,690 €	21
2002	1 L	Graduada	2,350 €	21
2004	1 L	Filtro	4,650 €	21



Calentador de leche

- Calientan un cubo de 8 L de 18°C a 42°C en 16 minutos

Ref.	Modelo	Peso	Ø	Tª máx	PVP	IVA
2040	Analógico	4,7 kg	160 mm	80 °C	210,950 €	21
2045	Digital	2,7 kg	165 mm	90 °C	329,850 €	21



Manguito de ordeño

Ref.	Cant.	Modelo	PVP	IVA
2155 *	2	Puño elástico	6,900 €	21
2155/D	100	Desechable	7,460 €	21

* Disponibles en azul / blanco



Paño de limpieza para ubres

- Reutilizables, lavables a máquina

Ref.	Cant.	Medidas	PVP	IVA
2140	10	34 x 34 cm	12,250 €	21
2020	50	34 x 37 cm	18,980 €	21



Cubo toallitas desinfección ubres

Ref.	Cantidad	PVP	IVA
2090	Cubo + 1.000 toallitas	26,950 €	21
2090/R	Rollo recambio 1.000 toallitas	21,950 €	21



Soplete de llama fría

- Gas no incluido

Ref.	PVP	IVA
2060	172,950 €	21

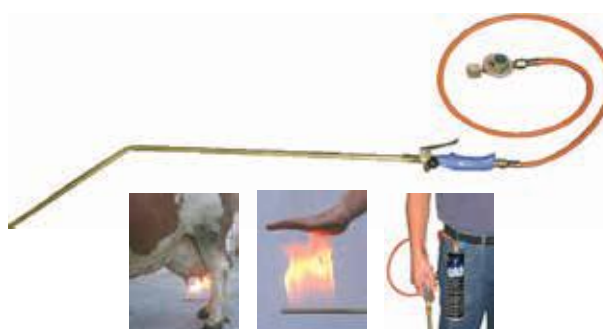

Separador de leche

Ref.	Capac.	PVP	IVA
2110	8 L	86,950 €	21
2111	12 L	51,950 €	21



Anulador de pezonera

Ref.	PVP	IVA
2130	1,690 €	21



Tubo recogida muestra de leche

Ref.	Capac.		PVP	IVA
2159	4 cc	1 / 2.000	0,095 €	21
2156	12 cc	1 / 250	0,259 €	21
2157	30 cc	1 / 400	0,199 €	21



Cubo de plástico de ordeño

- Asa de transporte 143mm
- Apta para instalaciones de ordeño móviles
- Compatible con instalaciones de marcas habituales (p.e. Westfalia)

Ref.	Capacidad	PVP	IVA
2106/V	30 L	104,950 €	21
2107/13	Tapa tubo 2 x Øint 13mm / Øext 17mm	23,950 €	21
2107/16	Tapa tubo 2 x Øint 16mm / Øext 20mm	23,950 €	21
2108	Junta tapa	13,950 €	21



Silla de ordeño

- Asiento de madera y cincha de sujección

Ref.	PVP	IVA
2030	21,950 €	21



Reactivo para test mamitis

Ref.	Capac.	Modelo	PVP	IVA
2115	1 L	CMT	6,350 €	21
2116	1 L	Lactotest	5,190 €	21



2115



2116

Bandeja para test mamitis

Ref.	Modelo	PVP	IVA
2120	Blanco	2,490 €	21
2123	Negro	2,250 €	21
2124	Con dosificador	26,950 €	21
2118	Dosificador 250 cc	2,490 €	21



2120



2123



2124



2118

Test

Ref.	Modelo	Detección	Cant.	PVP	IVA
2165	Krulab	PH *	100	37,950 €	21
2170	BHB	Acetona en leche	25	33,900 €	21
2172	Ketostix	Acetona en orina	50	25,200 €	21
2185	Dermafyt	Hongos	6	40,900 €	21
2125	Bovivet	Mamitis	25	3,550 €	21



2165



2170



2172



2185



2125

* PH, leucocitos, nitritos, proteínas, glucosa, acetona, bilirrubina y sangre

Medidor

Ref.	Modelo	PVP	IVA
2175	PH metro mano	45,850 €	21
2190	Densímetro de calostro	16,950 €	21
9270	Refractómetro de mano	125,950 €	21
9285	Refractómetro de calostro	59,950 €	21
9286	Refractómetro calostro digital % brix	228,350 €	21

2175

2190



9270



9285



9286



2141



2142

Vaso desinfección pezones

Ref.	Capac.	Modelo	PVP	IVA
2141	300 cc	RJB sin retorno *	8,550 €	21
2142	300 cc	RJB espuma *	12,450 €	21
2136	300 cc	Sin retorno	7,490 €	21
2137	300 cc	Espuma	10,950 €	21
2135	300 cc	Con retorno	4,100 €	21
2138	300 cc	Con retorno	1,700 €	21

* Bajo consumo



2136



2137



2135



2138

Pulverizador

Ref.	Capac.	Modelo	PVP	IVA
2152	500 cc	Con vaso	11,490 €	21
2151	500 cc	Sin vaso	10,250 €	21
2105	1.000 cc	Canyon A5	5,250 €	21
2153	500 cc	Sin vaso	11,950 €	21
2150	500 cc	Con alargador	4,990 €	21



2152



2151



2153



2105



2150

Sostén para ubres

Ref.	Talla	Sujeción	PVP	IVA
2010	Mediano	Normal	42,950 €	21
2015	Grande	Normal	42,950 €	21
2017	Extragrande	Normal	44,950 €	21
2003	Mediano	Al cuello	45,950 €	21
2005	Grande	Al cuello	45,950 €	21
2008	Extragrande	Al cuello	49,950 €	21



2010 - 2015 - 2017



2003 - 2005 - 2008

Dilatador de mamas Dr. Naylor

Ref.	Cant.	PVP	IVA
2210	40	10,950 €	21



Dilatador de mamas

Ref.	Cant.	PVP	IVA
2215	20	4,200 €	21



Cánula mamaria de cera

Ref.	Cant.	Material	PVP	IVA
2245	6	Cera	5,290 €	21



Cánula mamaria

Ref.	Cant.	Material	PVP	IVA
2265	20	Silicona	16,950 €	21



Cánula mamaria Bovi-vet cono Luer Lock

Ref.	Cant.	Modelo	PVP	IVA
2280	100	Esteril	7,590 €	21



Cánula mamaria Bovi-vet

Ref.	Cant.	Long.	PVP	IVA
2240	10	3,5 cm	4,990 €	21



Cánula mamaria Bengen

Ref.	Cant.	Long.	PVP	IVA
2220	10	7 cm	3,590 €	21
2230	10	5 cm	3,290 €	21



Ungüento para ubres Ice Mint

- Botes de 500 cc y 1.000 cc con gancho para colgar
- Sensación de frío / calor
- Mentolado

Ref.	Capac.	PVP	IVA
2250/500	500 cc	14,950 €	21
2250/1000	1.000 cc	28,950 €	21



Ungüento para ubres Cai-pan

- Botes de 400 cc y 500 cc con gancho para colgar
- Mentolado

Ref.	Capac.	PVP	IVA
2218	400 cc	14,950 €	21
2216	500 cc	16,950 €	21
2214	2.500 cc	69,950 €	21



Ungüento para ubres Euter Gel

- Mentolado

Ref.	Capac.	PVP	IVA
2236/500	500 cc	7,650 €	21
2236/1000	1.000 cc	14,250 €	21



Ungüento para ubres Eutra

Ref.	Capac.	PVP	IVA
2285/500	500 cc	8,950 €	21
2285/1000	1.000 cc	14,250 €	21



Cánula mamaria

Ref.	Long.	Modelo	PVP	IVA
2372	7 cm	Furstenberg plástico	2,290 €	21
2310	10 cm	Furstenberg metálica	2,250 €	21
2333	5 cm	Bartels	4,990 €	21
2334	8 cm	Bartels	5,190 €	21
2350	9 cm	Kaiser	2,990 €	21
2330	10 cm	Oliva	2,750 €	21
2320	7 cm	Cono Luer Lock	2,980 €	21



Aguja mamaria

Ref.	Long.	Modelo	PVP	IVA
2360	8 cm	Cono Luer Lock	3,650 €	21
2370	10 cm	Cono Luer Lock	3,950 €	21



Evacuador

Ref.	Long.	Modelo	PVP	IVA
2420	10 cm	Francés	2,950 €	21
2430	10 cm	Francés cortante	2,950 €	21
2440/H	13 cm	Hug cortante *	26,950 €	21
2440	16 cm	Hug cortante	3,500 €	21
2410	18 cm	Danés a cuchillas	4,950 €	21
2410/H	19 cm	Danés a cuchillas *	42,950 €	21

* Calidad Hauptner



Lanceta

Ref.	Long.	Modelo	PVP	IVA
2450	17 cm	Hug cabeza cortante	3,350 €	21



Sonda

Ref.	Long.	Modelo	PVP	IVA
2480	14 cm	Acanalada	2,950 €	21



Antiteta de plástico con cierre

Ref.	Tamaño	PVP	IVA
2510	Pequeña	4,290 €	21
2520	Mediana	4,290 €	21
2525	Mediana	2,490 €	21
2530	Grande	4,290 €	21



2510



2520



2530



2525

Antiteta de aluminio con cierre

Ref.	PVP	IVA
2540	1,750 €	21



Antiteta de muelle

Ref.	PVP	IVA
2575	3,580 €	21



Antiteta de plástico con anilla

Ref.	Anilla	PVP	IVA
2570	Ø 55 mm	8,950 €	21



Antiteta de caucho

Ref.	Tamaño	PVP	IVA
2565	Pequeña	8,550 €	21
2550	Mediana	18,950 €	21
2560	Grande	33,950 €	21



2565



2550 - 2560

Antiteta metálica para tenaza

Ref.	Puntas	Tamaño	PVP	IVA
2580	2	Pequeña	1,090 €	21
2585	2	Mediana	1,190 €	21
2590	4	Grande	1,590 €	21
2595	Tenaza aplicación		10,950 €	21



Cubo tetón terneros

Ref.	Capac.	Salidas	PVP	IVA
1560	7 L	1	6,950 €	21



Cubo tetón terneros

Ref.	Capac.	Salidas	Tetina	PVP	IVA
1510	8 L	1	Roja	6,200 €	21
1511	8 L	1	Caucho	6,200 €	21



Cubo tetón terneros Multi-Feeder

Ref.	Capac.	Salidas	PVP	IVA
1570	30 L	5	107,950 €	21
1570/C	Cubierta ajustable		11,450 €	21



Cubo tetón terneros Milk-Train

Ref.	Capac.	Salidas	PVP	IVA
2070	10 L	2	65,950 €	21



Válvula higiénica

- Fácil de desmontar y limpiar

Ref.	Cubo	Salidas	PVP	IVA
1645	Terneros 1510	1	5,850 €	21



Válvula cubo tetón

Ref.	Cubo	Salidas	Material	PVP	IVA
1625	Terneros 1560	1	Plástico	1,790 €	21
1620	Tern / Cord	1 / 3 / 5	Plástico	1,550 €	21
1621	Tern / Cord	Junta goma roja		0,250 €	21
1630	Corderos	6	Metal	0,450 €	21
1642	Corderos	6	Plástico	0,680 €	21



Cubo tetón corderos

Ref.	Capac.	Salidas	PVP	IVA
1515	8 L	3	12,550 €	21
1520	8 L	5	15,550 €	21
1540	8 L	6	11,950 €	21
1530	10 L	6	12,950 €	21



1515



1520



1540



1530

Cubo tetón corderos Multi-Feeder

Ref.	Capac.	Salidas	PVP	IVA
1572	30 L	5	91,950 €	21
1570/C	Cubierta ajustable		11,450 €	21



Cubo tetón corderos

Ref.	Capac.	Salidas	PVP	IVA
1575	12 L	6	22,950 €	21



Soporte para cubo tetón

Ref.	Material	PVP	IVA
1517/M	Metal	1,350 €	21
1517/P	Plástico	1,290 €	21



Tetina panel HIKO

Ref.	Uso	Descripción	PVP	IVA
1660	Terneros	Tetina panel completa	11,900 €	21
1660/01	Terneros	Válvula	2,750 €	21
1660/03	Terneros	Conector Y	1,490 €	21
1662	Corderos	Tetina panel completa	10,490 €	21
1662/01	Corderos	Válvula	2,590 €	21
1662/03	Corderos	Conector Y	2,490 €	21
1662/02	Tern / Cord	Tubo panel 100 m	69,950 €	21

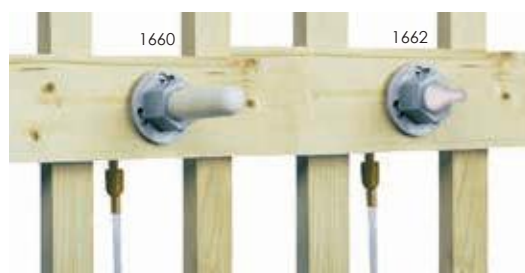

Tetina terneros

Ref.	Color	PVP	IVA
1720	Caucho	0,990 €	21
1712	Caucho	0,990 €	21
1710	Roja	0,890 €	21
1715	Blanca	0,990 €	21
1730	Látex	1,440 €	21



Tetina terneros

Ref.	Uso	PVP	IVA
1732	Biberón 2 L	3,850 €	21
1840	Flotante	3,350 €	21
1840/01	Flotante (solo tetina)	1,490 €	21
1782	Granulado	2,950 €	21
2070/01	Milk-Train	4,950 €	21



Tetina corderos para cubo tetón 1,3 y 5 salidas

Ref.	Color	Calidad	PVP	IVA
1828	Blanco	Hiko	0,990 €	21
1829	Marrón	Hiko	0,990 €	21
1825/H	Rojo	Hiko	0,990 €	21
1825	Rojo	B	0,699 €	21
1830	Caucho	B	0,440 €	21



Tetina corderos

Ref.	Uso	Calidad	PVP	IVA
1835	Cubo 6 salidas	B	0,399 €	21
1815	Botella	B	0,399 €	21
1838	Cabritos	Hiko	1,390 €	21
1810	Biberón Plexiglas	A	1,790 €	21
1811	Biberón Plexiglas	B	0,950 €	21
1823	Biberón / Botella	A	1,500 €	21
1850	Biberón blanco	B	0,790 €	21



Bolsa alimentación calostro para terneros CalostroStart

- Apta para congelación y pasteurización

Ref.	Descripción	PVP	IVA
1955	SET 10 (10 bolsas 4 L + 1 tetina + 1 sonda)	29,380 €	21
1956	Bolsa 4 L (5 uds)	13,950 €	21
1957	Tetina + rosca	4,950 €	21
1958	Sonda + rosca	7,950 €	21
1959	Funda térmica para bolsa 4 L	30,690 €	21

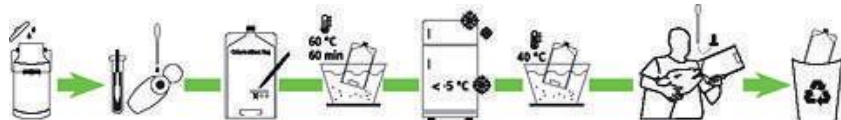

Bolsa alimentación calostro para terneros

- Con cremallera, fácil de llenar y limpiar para su reutilización
- Regulador de caudal
- Apta para congelación

Ref.	Capac.	PVP	IVA
1950	2,5 L	19,950 €	21



Manta impermeable para terneros

- Impermeable
- Lavable a máquina 30°C

Ref.	Long.	PVP	IVA
1940	70 cm	21,950 €	21
1945	80 cm	24,950 €	21



Manta impermeable para terneros Thermoplus

- Impermeable extra polyfleece
- Lavable a máquina 30°C
- Velcro de seguridad adicional

Ref.	Long.	PVP	IVA
1946	70 cm	36,550 €	21
1947	80 cm	37,950 €	21



Chubasquero para corderos

- Talla única

Ref.	Cant.	PVP	IVA
6185	25	17,950 €	21



Biberón corderos

Ref.	Capac.	Calidad	PVP	IVA
1910	500 cc	Plexiglas	5,490 €	21
1912	500 cc	B	3,950 €	21



1910



1912

Biberón para calostro corderos

Ref.	Capac.	PVP	IVA
1911	250 cc	9,950 €	21
1911/01	Sonda de repuesto	4,990 €	21



Biberón colgante corderos / terneros

Ref.	Capac.	Tetina	PVP	IVA
1914/C	1 L	Corderos	4,150 €	21
1914/T	1 L	Terneros	4,150 €	21



Biberón corderos / terneros

Ref.	Capac.	Tetina	Asa	PVP	IVA
1916/T	2 L	Terneros	No	4,990 €	21
1616/C	2 L	Corderos	No	4,990 €	21
1917/T	2 L	Terneros	Sí	5,590 €	21
1922	Soporte biberón 2 L			3,990 €	21



1916



1917/T



1922

Biberón terneros

Ref.	Capac.	Asa	PVP	IVA
1919	3 L	Sí	6,950 €	21



Sonda Calf Drencher terneros Bovivet

Ref.	Capac.	Sonda	PVP	IVA
1920	2 L	Rígida	10,950 €	21
1925	2 L	Flexible	13,950 €	21
1960	4 L	Rígida	13,495 €	21
1965	4 L	Flexible	17,495 €	21



Biberón terneros

Ref.	Capac.	Modelo	PVP	IVA
1918	3 L	Tetina	11,490 €	21
1930	3 L	Sonda flexible	17,950 €	21



Biberón terneros

Ref.	Capac.	Modelo	PVP	IVA
1979	1,2 L	Easy Drencher	20,950 €	21
1915	2,5 L	Speedy Feeder	36,950 €	21
1982	4 L	Granulado	16,990 €	21



Bebedero acero inox. tipo chupete

Ref.	Modelo	Uso	Rosca	PVP	IVA
10209	Pequeño	Lechón	Latón 3/8"	2,950 €	21
10210	Pequeño	Lechón	Latón 1/2"	3,050 €	21
10215	Mediano	Cebo	Latón 1/2"	3,550 €	21
10220	Grande	Cerda	Latón 1/2"	4,950 €	21



10209



10210



10215



10220

Bebedero acero inox. tipo chupete

Ref.	Rosca	PVP	IVA
10225	Acero 1/2"	3,050 €	21



Bebedero latón tipo chupete

Ref.	Rosca	PVP	IVA
10250	Latón 1/2"	2,850 €	21



Bebedero acero inox. chupete corto

Ref.	Rosca	PVP	IVA
10234	Acero 1/2"	2,950 €	21



Bebedero acero inox. rosca hembra

Ref.	Rosca	PVP	IVA
10211	3/8"	2,950 €	21



Bebedero acero inox. alto caudal rosca hembra

Ref.	Rosca	PVP	IVA
10207	1/2"	6,980 €	21



Bebedero tipo aspersor

Ref.	Material	Rosca	PVP	IVA
10230	Acero inox.	Acero 1/2"	2,950 €	21
10232	Latón	Latón 1/2"	3,950 €	21



10230



10232

Comedero porcino acero

Ref.	Ø	PVP	IVA
10206	25 cm	15,950 €	21



Comedero porcino PVC

Ref.	Ø	PVP	IVA
10208	24 cm	16,900 €	21



Bebedero acero inox. cazoleta porcino

- Rosca acero inox. 1/2"

Ref.	Uso	Medidas	PVP	IVA
10200	Lechón	15 x 21 x 9 cm	23,950 €	21
10202	Cebo	19 x 27 x 11 cm	29,950 €	21
10204	Cerda	21 x 29 x 16 cm	35,950 €	21
10204/01	Recambio chupete 1/2" macho		4,450 €	21



Bebedero aluminio vacuno, ovino y equino con boya

- Conexión por parte izquierda o derecha
- Conector de 1/2"

Ref.	Ø	PVP	IVA
10330	21 cm	33,950 €	21



Bebedero galvanizado vacuno, ovino y equino con boya

- Conexión por parte izquierda o derecha
- Conector de 1/2"

Ref.	Ø	PVP	IVA
10332	28 x 26 cm	36,950 €	21



Bebedero PVC vacuno, ovino y equino con boya

- Bebedero económico con flotador de polipropileno
- Conexión de 1/2" izquierda o derecha
- Incluye tapón de vaciado

Ref.	Medidas	PVP	IVA
87055	29 x 25,5 x 14,5 cm	21,950 €	21



Bebedero palanca regulable en altura

Ref.	Capac	PVP	IVA
10340	5 L	29,950 €	21



Bebedero hierro fundido Suevia 61 vacuno con palanca

- Conexión por parte superior o inferior
- Conectores de 1/2"

Ref.	Ø	PVP	IVA
10375	21 cm	46,950 €	21



Bebedero PVC vacuno y equino con lengüeta

- Conexión por parte superior o inferior
- Adaptable a conectores de 1/2" y 3/4"

Ref.	Ø	Lengüeta	PVP	IVA
10360	20,5 x 22 cm	PVC	22,950 €	21



Bebedero hierro fundido vacuno y equino con lengüeta

- Conector de 1/2" por parte superior o inferior

Ref.	Ø	Lengüeta	PVP	IVA
10310	20 cm	Acero inox.	23,950 €	21
10320	25 cm	Hierro fundido	31,950 €	21



10310



10320

Bebedero aluminio vacuno con lengüeta para contenedor de agua para pasto

- Válvula de baja presión

Ref.	Ø	PVP	IVA
10335	21 cm	49,950 €	21



Bebedero PVC vacuno de nivel

Ref.	Medidas	Capac.	PVP	IVA
10201	685 x 457 x 255 cm	53 L	99,900 €	21
10201/2	889 x 508 x 330 cm	106 L	123,950 €	21



Abrevadero PVC vacuno

- Boya para colgar opcional

Ref.	Medidas	Capac.	Tapón	PVP	IVA
10365	102 x 73 x 36 cm	150 L	No	115,890 €	21
10370	130 x 85 x 62 cm	380 L	Si	160,890 €	21
10371	Boya			22,890 €	21



Bebedero PVC térmico vacuno

- Conectores de 1/2"
- Válvula flotador con caudal de agua de hasta 35 l/min
- Temperatura aprox. 3 - 5 °C en invierno / 10 - 12 °C en verano)
- Tapón de desagüe Ø 100 mm

Ref.	Medidas	Capac.	PVP	IVA
10378	60 x 70 x 52,5 cm	40 L	489,950 €	21
10379	108,5 x 70 x 52,5 cm	100 L	645,950 €	21



Bebedero acero inox. vacuno / equino

- Conector de 1/2"
- Válvula flotador con caudal de agua de hasta 30 l/min
- Desagüe de 2" en la parte inferior central

Ref.	Medidas	Capac.	PVP	IVA
10203	500 x 400 x 290 cm	35 L	368,950 €	21



Soporte para bloque mineral

Ref.	Medidas	Bloque	PVP	IVA
10260	22,5 x 20 cm	Rectangular	3,240 €	21
10262	18,5 x 19 cm	Circular	3,950 €	21



Comedero PVC

Ref.	Medidas	Capac.	PVP	IVA
10290	33 x 33,5 x 28 cm	9 L	13,950 €	21
10295	42 x 33 x 30 cm	15 L	18,950 €	21



10290

10295

Comedero PVC para colgar

Ref.	Medidas	Capac.	PVP	IVA
10290/8	35 x 27 x 25 cm	8 L	8,950 €	21
10290/13	37 x 28 x 32 cm	13 L	13,550 €	21



10290/8

10290/13

Comedero PVC con colgadores de metal

Ref.	Asa metal	Capac.	PVP	IVA
10275	Si	12 L	13,950 €	21
10277	No	12 L	11,450 €	21



10275

10277

Comedero PVC para esquinas con protector

Ref.	Medidas	Capac.	PVP	IVA
10279	60 x 30 x 45 cm	31 L	26,950 €	21



Capazo plástico flexible con asas

Ref.	Medidas	Capac.	PVP	IVA
10298	40 x 31 cm	31 L	9,950 €	21



Cubo plástico con asa de metal

Ref.	Medidas	Capac.	PVP	IVA
10290/20	37 x 29 cm	20 L	11,950 €	21



Comedero galvanizado semicircular

- Tapón de vaciado Ø 15 mm

Ref.	Medidas	Capac.	PVP	IVA
10268	55 x 35 x 24 cm	28 L	54,950 €	21



Comedero galvanizado rectangular

- Tapón de vaciado Ø 15 mm

Ref.	Medidas	Capac.	PVP	IVA
10271	45 x 34 x 23 cm	35 L	54,950 €	21



Comedero galvanizado para esquina

- Tapón de vaciado Ø 15 mm

Ref.	Medidas	Capac.	PVP	IVA
10269	44 x 44 x 24 cm	35 L	54,950 €	21



Forrajera galvanizada

- Para fijación en pared
- Distancia entre barras: 101 mm
- Ø barra: 8 mm

Ref.	Medidas	PVP	IVA
10218	68 x 41 x 45,5 cm	30,950 €	21



Forrajera galvanizada

- Para fijación en pared
- Distancia entre barras: 96 mm
- Ø barra: 10 mm

Ref.	Medidas	PVP	IVA
10218/R	80 x 45 x 45 cm	52,950 €	21



Forrajera galvanizada para esquina

- Para fijación en pared
- Distancia entre barras: 105 mm
- Ø barra: 10 mm

Ref.	Medidas	PVP	IVA
10218/E	70 x 52 x 61 cm	38,950 €	21



Forrajeras

Ref.	Modelo	PVP	IVA
10255	Red	5,550 €	21
10257	Saco	10,950 €	21



10255



10257

Cazo aluminio

Ref.	Capac.	PVP	IVA
10270	2.500 gr	18,890 €	21



Cazo acero

Ref.	Capac.	PVP	IVA
10264	2.000 ml	14,950 €	21



Cazo acero

Ref.	Capac.	PVP	IVA
10266/1L	1.000 ml	8,950 €	21
10266	2.000 ml	11,950 €	21



Cazo plástico

Ref.	Capac.	PVP	IVA
10267	1.000 ml	2,750 €	21



Los cercados eléctricos

La principal diferencia con un cercado normal es la descarga eléctrica que recibe el animal al tocar el cercado. Dichas descargas no son peligrosas para animales o personas, pero les persuaden de intentar volver a tocarlo. Tendremos que tener en cuenta si queremos el cercado para contener ganado o evitar que la fauna salvaje entre.

Elementos de un cercado eléctrico:

- 1.- El pastor eléctrico genera los impulsos que recorren el cercado.
- 2.- Los hilos superconductores transmiten la energía.
- 3.- Los aisladores evitan que la corriente se pierda.
- 4.- Cuando el animal toca el cercado eléctrico, la energía lo recorre hasta llegar al suelo.
- 5.- La corriente eléctrica viaja por el suelo.
- 6.- Las picas de toma de tierra facilitan que la corriente eléctrica retorne al pastor.

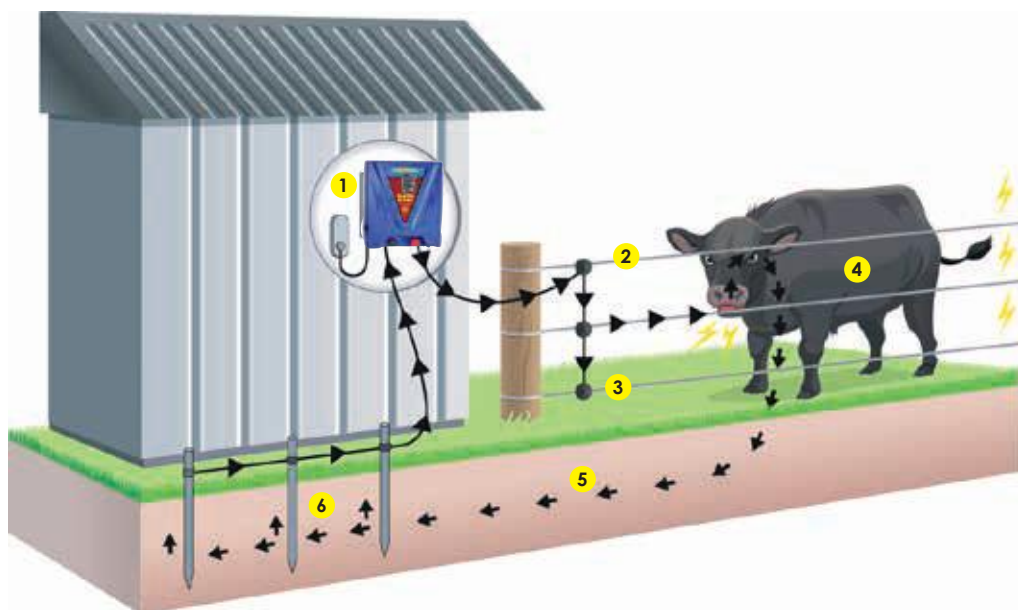

Factores que influyen en el correcto funcionamiento de una cercado eléctrico:

1.- La conductividad del hilo

Cuanto mayor es el perímetro del cercado, mayor conductividad tendrán que tener los hilos y habrá que tener en cuenta la vegetación que haya. Por ejemplo, usando hilos de 4 x 2,5 y si no hay vegetación, el cercado puede llegar a tener 120 Km. de perímetro. Con un solo hilo, el perímetro bajaría a los 30 Km. Y si usamos un hilo de 6 x 0,20 de acero inox, el perímetro se reduce hasta los 250 m. y aún menos con vegetación alta.

Por lo tanto, tenemos que tener en cuenta tanto la distancia del perímetro como la vegetación existente. Para la elección del hilo, tendremos que tener cuenta las siguientes resistencias:

- Perímetro < 400 m: máx. 2,4 ohms/m
- Perímetro < 3.000 m: máx. 0,32 ohms/m
- Perímetro < 8.000 m: máx. 0,13 ohms/m

2.- La toma de tierra

Un cercado eléctrico es un circuito por el cual la corriente eléctrica fluye a través del hilo, el animal y la tierra. La energía necesita de las picas de tierra para poder volver al pastor eléctrico. Las picas de toma de tierra deberán ponerse en suelos lo más húmedos posibles. En caso de que el terreno sea especialmente seco, o sea de arena o piedra, es vital colocar la toma de tierra adecuada para que el funcionamiento sea el correcto.

Tendremos que tener en cuenta lo siguiente:

- Para pastores de red y batería: 3 picas de tierra de 1-2 m son suficientes.
- Para pastores portátiles: 1 pica de tierra de 1 m, aunque en climas secos recomendamos picas adicionales.
- Todas las conexiones deben estar hechas correctamente.
- Las picas de toma de tierra deben ser completamente galvanizadas.
- Comprobar el estado de las picas regularmente.

Para pastores eléctricos entre 1 y 5 julios de potencia recomendamos 3 picas de tierra de 1 m. correctamente conectadas entre sí mediante un cable de alto voltaje y tornillos y una distancia de 3 m entre unas y otras.

3.- El pastor eléctrico

Es la fuente de energía del cercado eléctrico y medimos su potencia de salida en julios.

Para la elección del pastor, tenemos que tener en cuenta los siguientes factores:

- El nivel de vegetación
- El perímetro de la cerca o número de hilos
- El tipo de animal
- El suministro de energía: 9 V / 12V ó 230 V

La potencia de salida requerida para el pastor nos la marcará el perímetro de la cerca y la cantidad de vegetación:

- Perímetro < 500 m sin vegetación: min. 0,25 julios
- Perímetro < 1.000 m y vegetación media: min. 2 julios
- Perímetro < 1.000 m y vegetación alta: min. 6 julios

¿Cómo elegir el pastor eléctrico correcto?

Para una correcta elección, tendremos que tener en cuenta 4 puntos:

1.- La vegetación

Hay que saber qué vegetación existe en el cercado. La energía de salida de los pastores eléctricos puede quemar la vegetación y mantener así el nivel de electricidad del cercado. Podemos distinguir hasta 4 tipos distintos de vegetación:

Baja: no hay contacto entre la vegetación y el hilo

Moderada: hay contacto con el hilo ocasionalmente

Media: hay un contacto continuo de la vegetación con el hilo

Alta: la vegetación toca completamente el hilo

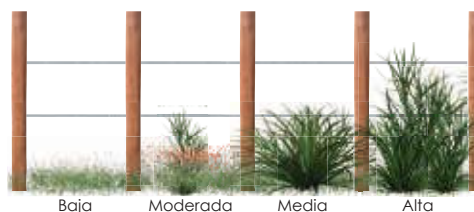

2.- El perímetro del cercado

El perímetro es la longitud que tiene el cercado que queremos electrificar. Cuantas más líneas tenga el cercado eléctrico, mejor funcionará ya que la corriente eléctrica fluye mejor, siempre y cuando los hilos estén conectados entre ellos a intervalos regulares.



3.- El tipo de animal

Dependiendo el tipo de animal que queremos contener o del tipo de fauna salvaje que queremos evitar, usaremos pastores eléctricos más o menos potentes.

Animales fáciles de contener: vacas, toros, caballos, perros y gatos

Animales difíciles de contener: ovejas, cabras, aves y fauna salvaje

4.- El pastor eléctrico

Hay 4 clases de pastores en base a la fuente de energía que utilizan:

- 230 V enchufados a la red eléctrica: los más económicos y fáciles de usar. Son los recomendables siempre que haya cerca una red eléctrica.
- 12 V a baterías recargables: opción económica cuando no hay una red eléctrica cerca, pero conllevan que hay que recargar las baterías.
- 12 V a baterías con paneles solares: la mejor opción para los pastores de 12 V más potentes.
- 9 V a pilas no recargables: fáciles de usar, pero tienen la desventaja de su poca potencia.

Además, tendremos que tener en cuenta 2 parámetros a la hora de escoger el pastor eléctrico adecuado:

* La energía de salida = julios

Es la energía máxima del impulso eléctrico que el pastor emite al cercado. Cuanto más alto es el valor, mayor es el calor que recibe el animal y mayor es la destrucción de la vegetación en contacto.

Pastores eléctricos < 0,5 julios: recomendados para animales fáciles de contener y cercados con poca vegetación

Pastores eléctricos 1 - 5 julios: recomendados para animales difíciles de contener y cercados con vegetación media

Pastores eléctricos > 5 julios: recomendados para cercados grandes con vegetación alta

* El voltaje por debajo de carga = voltios

El voltaje óptimo debe estar entre 3.000 y 4.000 voltios, y nunca por debajo de 2.000 voltios. Los pastores eléctricos ofrecen distintos valores de voltaje en función de la resistencia, y se considera un funcionamiento normal un valor alrededor de los 500 ohmios.

Consejos para la correcta utilización de pastores eléctricos de 12 V

- Utilizar pastores de 12 V cuando no hay acceso a la red eléctrica, intentando colocarlo lo más cerca posible del cercado.
- Debido a que las baterías de 12 V necesitan recarga regularmente, es recomendable que el pastor esté en un sitio accesible pero discreto para evitar posibles robos.
- Utilizar siempre una batería de capacidad adecuada y que estén preparadas para paneles solares. Para las recargas sin panel solar, es altamente recomendable el uso de cargadores automáticos de calidad.
- Gracias a un panel solar adecuado, la recarga no sería necesaria entre primavera y otoño.
- Hay que revisar la conexión a tierra cada vez que se cambie la batería.
- Es conveniente tener una batería de recambio.
- Las picas de conexión a tierra deben colocarse cerca del pastor, y donde el suelo esté más húmedo.
- Colocar carteles de aviso por cercado eléctrico.
- Comprobar el correcto funcionamiento del cercado eléctrico después de la instalación.
- Cuando la energía aportada por el panel solar supera al consumo del aparato, la sobrante es aprovechada para alimentar la batería. Sin embargo, los pastores no están pensados para cargar baterías descargadas, por lo que es conveniente que cuando pongamos el pastor en funcionamiento por primera vez o a principios de temporada, dispongamos de una batería con su máxima potencia de carga.

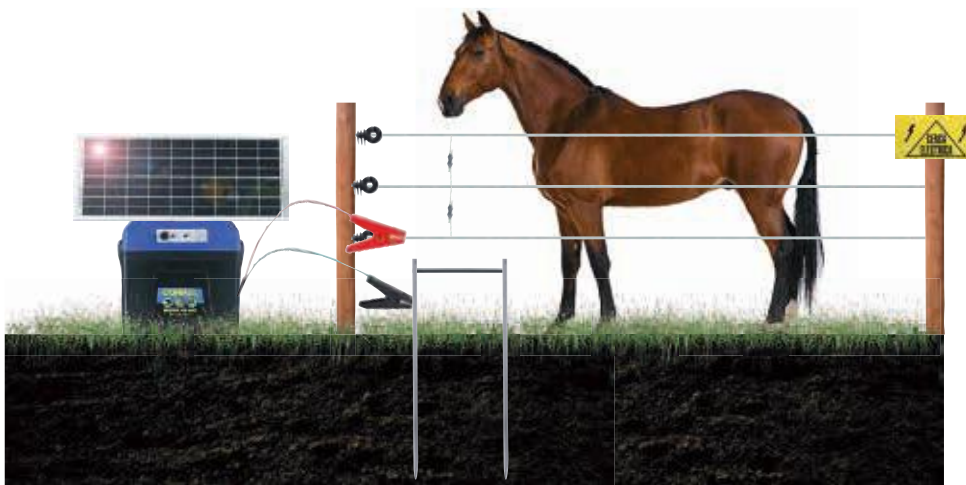

Consejos para la correcta utilización de pastores eléctricos a red 230 V

- Utilizar pastores a red de 230 V cuando haya acceso a la red eléctrica cerca, con una distancia máxima de hasta 200 metros.
- Colocar el pastor eléctrico en un lugar adecuado, como por ejemplo debajo de algún tejado o en la parte trasera de una pared.
- Si se quiere instalar dentro de un local, hay que tener precaución que no haya riesgo de incendio.
- El pastor debe conectarse con cables de alto voltaje al cercado y a las picas de tomas de tierra.
- Las picas de toma de tierra deben colocarse lejos del edificio, preferiblemente en un sitio húmedo.
- Revisar anualmente las picas de tomas de tierra.
- Es recomendable proteger los pastores eléctricos de subidas y bajadas de tensión mediante un protector de tensión.
- Colocar carteles de aviso por cercado eléctrico.
- Se recomienda colocar un pararrayos (*).

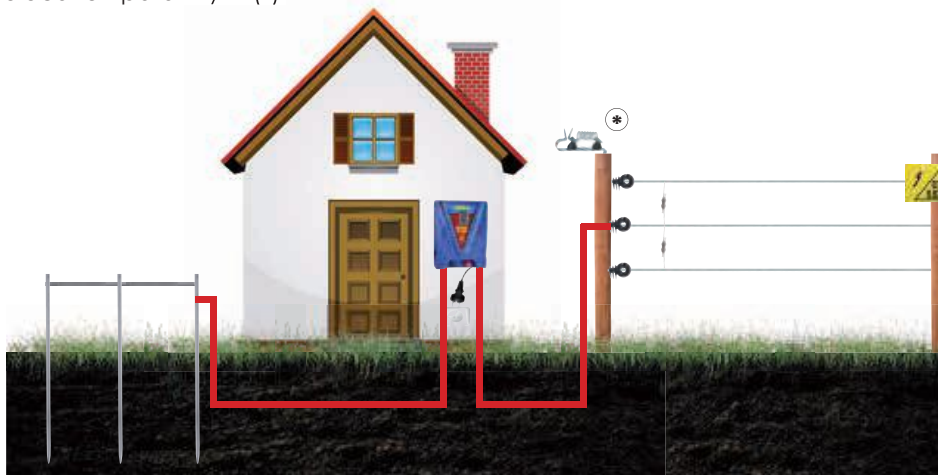

Contención o entrada

Los cercados eléctricos están pensados para contener o evitar la entrada a todo tipo de animales, para ello solamente se diferencian en la altura, número de hilos conductores y el material de los mismos.

Hay que tener claro si se quiere contener a los animales o evitar la entrada de fauna salvaje. La contención siempre es más sencilla, ya que los animales que están dentro enseguida aprenden que evitar los cercados. Sin embargo, si queremos evitar la entrada, puede ocurrir que cada vez venga un animal distinto y que por lo tanto éste no hay tenido contacto todavía con el cercado eléctrico y por lo tanto hay que asegurarse de que el animal reciba un calambre lo suficientemente significativo para que evite el cercado la próxima vez. Por lo tanto, los pastores eléctricos para evitar la entrada de fauna salvaje derán ser más potentes.

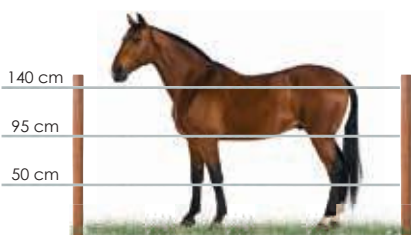

Pastor eléctrico a red 230 V

- La mejor opción cuando hay cerca una red eléctrica
- Muy eficientes y de bajo consumo

Ref.	Poten.	230V	9V	12V	Solar	PVP	IVA
2785	5 W	X				102,950 €	21
2790	5 W	X				108,950 €	21
2787	7 W	X				149,950 €	21





Ref.				
2785	1,60 J	1,10 J	10,0 Km	1
2790	3,50 J	1,70 J	17,0 Km	2
2787	5,50 J	3,50 J	20,0 Km	3



Pastor eléctrico a red / batería 12 V

- Batería no incluida (recomendamos ref.2830/2840)
- Protección contra la descarga total de la batería de 12 V
- **Adaptador a red y pinzas de conexión a batería incluidos**

Ref.	230V	9V	12V	Solar	PVP	IVA
2715	X		X		116,950 €	21
2717	X		X		152,950 €	21

Ref.				
2715	1,10 J	0,80 J	10,0 Km	1
2717	2,60 J	1,80 J	18,0 Km	2



Pastor eléctrico batería 12 V recargable

- **Adaptador de baterías y batería incluidos**

Ref.	230V	9V	12V	Solar	PVP	IVA
2775			X		192,950 €	21

Ref.				
2775	2,50 J	1,60 J	12,0 Km	2



Pastor eléctrico a red 230V / batería 9 V / batería 12 V

- Puede funcionar de las siguientes maneras:
 - Red 230V: adaptador no incluido (ref. 2781)
 - Batería 9V: no incluida (ref. 2852 / 2852-170)
 - Batería 12V: no incluida (ref.2830/2840)

- Pinzas de conexión a cercado y soporte para pastor incluidos**

Ref.	230V	9V	12V	Solar	PVP	IVA
2725	X	X	X		109,950 €	21
2781	Cargador a red 230 V				28,950 €	21

Ref.				
2725 9V	0,25 J	0,17 J	3,0 Km	1
2725 12V	0,32 J	0,22 J	3,5 Km	1







Pastor eléctrico a red 230V / batería 9 V / batería 12 V

- Muy versátil, puede funcionar de las siguientes maneras:
 - Red 230V: adaptador incluido
 - Batería 9V: no incluida (recomendamos ref. 2852/170)
 - Batería 12V: no incluida (recomendamos ref.2830/2840)

- Conexión a batería 9V, pinzas de conexión a batería 12V y adaptador a red 230V incluidos**

Ref.	230V	9V	12V	Solar	PVP	IVA
2782	X	X	X		149,950 €	21

Ref.				
2782 9V	0,40 J	0,28 J	4,0 Km	1
2782 12V	0,54 J	0,34 J	4,5 Km	1



Pastor eléctrico a red 230 V / batería 9 V / batería 12 V / solar

- Idóneo para cualquier situación, puede funcionar de las siguientes maneras:
 - Red 230V: adaptador no incluido (ref.2778)
 - Batería 9V: no incluida (recomendamos ref.2852/2852-170)
 - Batería 12V: no incluida (recomendamos ref.2830/2840)
 - 2777/S Solar: panel 8W incluido

- Pinzas de conexión a batería 9V / 12V y de conexión a cercado incluidas**

Ref.	230V	9V	12V	Solar	PVP	IVA
2777	X	X	X		278,950 €	21
2777/S	X	X	X	X	364,950 €	21
2778	Cargador a red 230 V				26,950 €	21

Ref.				
2777 9V	1,00 J	0,50 J	5,0 Km	1
2777 12V	2,30 J	1,50 J	10,0 Km	2



2777

2777/S

Pastor eléctrico batería 12 V / solar

- 2792: pinzas de conexión incluidas
- 2792/S: pinzas de conexión, panel solar 15W y soporte incluidos
- 2795: pinzas de conexión y cubierta metálica incluidos
- 2795/S: pinzas de conexión, panel solar 15W y cubierta metálica incluidos
- Batería no incluida (recomendamos ref.2830/2840)

Ref.	230V	9V	12V	Solar	PVP	IVA
2795			X		158,950 €	21
2795/S			X	X	325,950 €	21
2792			X		182,950 €	21
2792/S			X	X	369,950 €	21

Ref.				
2795	1,40 J	1,00 J	10,0 Km	2
2792	4,80 J	3,00 J	25,0 Km	3



2795



2792



2795/S



2792/S

Pastor eléctrico solar

- Indicado para cercados pequeños y sin vegetación
- **Batería de gel 12V 7Ah y panel solar 2W incluidos**
- Adaptador de red para batería para su uso en invierno opcional

Ref.	230V	9V	12V	Solar	PVP	IVA
2793				X	251,950 €	21
2783	Adaptador a red para batería gel				26,950 €	

Ref.				
2793	0,23 J	0,18 J	2,0 Km	-



Panel solar para pastor eléctrico

Ref.	Potencia	Medidas	PVP	IVA
2733	5 W	15 x 30 cm	89,950 €	21
2735	6 W	15 x 30 cm	93,950 €	21
2734	8 W	31 x 43 cm	99,950 €	21
2736	15 W	37,5 x 42 cm	164,950 €	21



Adaptador a red 230 V para pastor eléctrico

Ref.	Pastor	PVP	IVA
2778	2777	26,950 €	21
2781	2725 / 2782	28,950 €	21
2783	2793	26,950 €	21



2778 - 2783



2781

Pinza de conexión

Ref.	Conexión	Long.	PVP	IVA
2838	Batería 9V / 12V	80 cm	14,490 €	21
2837	Batería 12V	100 cm	9,950 €	21
2860	Pastor a pica de tierra M8	100 cm	4,950 €	21
2875	Pastor a cercado de hilo M8	100 cm	4,950 €	21
2805	Cercado M8	125 cm	3,150 €	21



2860



2838



2875



2837



2805

Conector para cintas (hasta 40 mm)

Ref.	Conexión	Long.	PVP	IVA
2826	1 cinta M8	130 cm	4,950 €	21
2828	2 cintas	80 cm	7,990 €	21

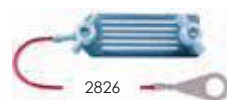

2826

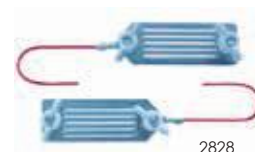

2828

Cable de conexión

Ref.	Conexión	Long.	PVP	IVA
2824	Tierra M8	100 cm	2,250 €	21



Pila alcalina

Ref.	Voltaje	Medidas	PVP	IVA
2852	9V 75Ah	16 x 11 x 11 cm	20,950 €	21
2852/170	9V 170Ah	19 x 12 x 16 cm	38,950 €	21



Batería pastor recargable 2775

Ref.	Voltaje	Medidas	PVP	IVA
2775/01	12V 7Ah	15 x 6,5 x 9 cm	32,950 €	21
2775/08	12V 12Ah	15 x 9,5 x 9,5 cm	45,950 €	21



Batería recargable

- Sin mantenimiento

Ref.	Voltaje	Medidas	PVP	IVA
2830	12V 45Ah	21 x 18 x 19 cm	89,900 €	21



Batería recargable de descarga lenta

- Por seguridad suministrada vacía, sin ácido sulfúrico (3 L)
- Específica para pastores eléctricos

Ref.	Voltaje	Medidas	PVP	IVA
2840	12V 55Ah	20 x 17 x 19 cm	103,890 €	21



Comprobador de cercados digital

- Pila 9 V incluida

Ref.	Medición	PVP	IVA
3270	10.000 V	45,950 €	21



Comprobador de cercados

- No necesita pila

Ref.	Medición	PVP	IVA
3280	6.000 V	14,950 €	21
3285	10.000 V	15,950 €	21



Comprobador de cercados

- Pila incluida
- Aviso acústico y visual
- Tamaño reducido con argolla para llavero

Ref.	PVP	IVA
3255	8,950 €	21



Comprobador de baterías digital AC/DC

- Pilas 1,5V incluidas

Ref.	Medición	PVP	IVA
3250	0,5 - 600 V	34,950 €	21



Cinta superconductora blanca

Ref.	Ancho	Long.	Conduc.	Ω/m	Rupt.	PVP	IVA
3110	12,5 mm	200 m	4 x 0,16	11	75 Kg	9,950 €	21
3120	20 mm	200 m	4 x 0,16	11	90 Kg	11,550 €	21
3130	40 mm	200 m	8 x 0,16	5,5	130 Kg	20,550 €	21



Cinta superconductora bicolor

Ref.	Ancho	Long.	Conduc.	Ω/m	Rupt.	PVP	IVA
3135	10 mm	250 m	4 x 0,16	11	60 Kg	11,900 €	21
3140	20 mm	200 m	6 x 0,20	2,56	120 Kg	16,950 €	21



Cinta superconductora blanca y verde

Ref.	Ancho	Long.	Conduc.	Ω/m	Rupt.	PVP	IVA
3101	12,5 mm	200 m	5 x 0,20	0,25	80 Kg	21,950 €	21
3102	20 mm	200 m	6 x 0,20	0,17	180 Kg	32,900 €	21
3103	38 mm	200 m	10 x 0,20	0,13	270 Kg	51,950 €	21



Hilo superconductor blanco

Ref.	Long.	Conduc.	Ω/m	Rupt.	PVP	IVA
3162	200 m	6 x 0,30	0,31	100 Kg	13,950 €	21
3160	400 m	6 x 0,30	0,31	100 Kg	26,950 €	21
3164	400 m	9 x 0,20	2,58	100 Kg	28,900 €	21



Hilo superconductor bicolor

Ref.	Long.	Conduc.	Ω/m	Rupt.	PVP	IVA
3150	250 m	3 x 0,16	11	45 Kg	6,890 €	21
3152	500 m	3 x 0,16	11	45 Kg	11,950 €	21



Cordón superconductor

Ref.	Ø	Long.	Conduc.	Ω/m	Rupt.	PVP	IVA
3175	6 mm	200 m	6 x 0,20	3,87	350 Kg	21,950 €	21
3185	6 mm	500 m	6 x 0,20	3,87	350 Kg	51,950 €	21



Cable acero galvanizado

Ref.	Ø	Long.	Ω/m	Rupt.	PVP	IVA
3105	1,8 mm	250 m	0,05	110 Kg	14,950 €	21



Cable alambre galvanizado

Ref.	Ø	Long.	Ω/m	Rupt.	PVP	IVA
3170	1,5 mm	200 m	0,12	200 Kg	9,890 €	21



Cable aluminio

Ref.	Ø	Long.	Ω/m	Rupt.	PVP	IVA
3165	1,6 mm	400 m	0,02	60 Kg	26,950 €	21
3168	1,8 mm	400 m	0,015	75 Kg	32,950 €	21
3169	2,0 mm	400 m	0,010	90 Kg	37,950 €	21



Cable toma de tierra

- Ojales de M8

Ref.	Ø ext.	Long.	Ω/m	PVP	IVA
2865	7 mm	3 m	0,025	6,950 €	21
2866	7 mm	8 m	0,025	11,950 €	21



Cable cobre forrado

- Para pastores de red y toma de tierra

Ref.	Ø ext.	Long.	Ω/m	PVP	IVA
2822	7 mm	50 m	0,025	29,950 €	21



Red para cercados

- Postes de PVC con punta galvanizada
- Hilo horizontal electrificable, conductores 3 x 0,20
- 14 postes

Ref.	Altura	Long.	Modelo	PVP	IVA
2810	90 cm	50 m	Reforzado	94,850 €	21
2820	108 cm	50 m	Sencillo	99,900 €	21



Pastor eléctrico, cartel y cable no incluido

Poste para cercados

Ref.	Material	Medidas	PVP	IVA
3082	Madera	180 x 8 cm	9,550 €	21
3083	Madera	200 x 10cm	14,590 €	21
3084	Metal (en ángulo)	115 cm x 2 mm	2,790 €	21
3086	Metal (en ángulo)	115 cm x 3 mm	2,990 €	21
3088	Metal (toma tierra)	100 cm	9,950 €	21
3087	Plástico	113 cm	2,950 €	21
3210	Plástico	105 cm	1,590 €	21
3220	Plástico	150 cm	3,950 €	21
3230	Fibra vidrio	125 cm x Ø 12 mm	1,320 €	21
3235	Fibra vidrio	150 cm x Ø 12 mm	1,920 €	21
3245	Fibra vidrio	200 cm x Ø 12 mm	2,500 €	21



Recogedor con cincha

- Válido para:
 - 600 m cinta 10 mm
 - 500 m cordón Ø 6 mm
 - 1.000 m cable Ø 3 mm

Ref.	Descripción	PVP	IVA
2920	Recogedor	21,950 €	21
2920/01	Carrete de recambio	13,890 €	21



Recogedor con asa

- Válido para:
 - 200 m cinta 10 mm
 - 200 m cordón Ø 6 mm
 - 400 m cable Ø 3 mm

Ref.	Descripción	PVP	IVA
2910	Recogedor	11,660 €	21
2910/01	Carrete de recambio	6,950 €	21



Cierre tensor

- Extensible hasta 5 m



Ref.	Descripción	PVP	IVA
2930	Cierre completo	5,950 €	21
2930/02	Muelle de repuesto	3,950 €	21

Muelle tensor

Ref.	Largo	Ø	Material	PVP	IVA
3032	435 mm	43 mm	Galvanizado	6,690 €	21
3033	435 mm	43 mm	Acero inox	10,950 €	21
3034	200 mm	25 mm	Acero inox	4,950 €	21

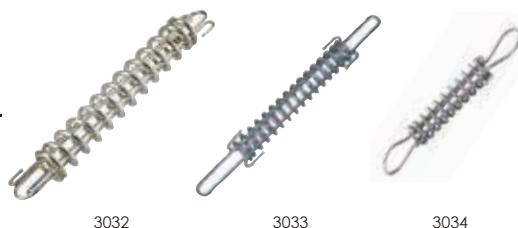

Cierre tensor

Ref.	Color	Modelo	PVP	IVA
2940	Negro	Abierto	1,890 €	21
2945	Amarillo	Abierto	1,890 €	21
2950	Negro	Cerrado	1,990 €	21
2955	Negro	Abierto *	2,950 €	21

* incluye rácor para cinta de hasta 40 mm



Cierre tensor con muelle

- Extensible hasta 5 m

Ref.	PVP	IVA
2940/5M	4,900 €	21



Cierre tensor con muelle

- Extensible de 4,5 a 9 m
- Incluye cuerda con gancho, cierre tensor y 2 aisladores

Ref.	PVP	IVA
2915	5,350 €	21



Cierre extensible con recogedor

- Extensible hasta 7,5 m

Ref.	Modelo	PVP	IVA
2935	Hilo Ø 6 mm	31,950 €	21
2936	Cinta 40 mm	31,950 €	21



Aislador doble para hilo

Ref.	Poste		PVP	IVA
2930/01	Madera	1 / 10	0,790 €	21



Aislador para hilo

Ref.	Poste	Color	Long.		PVP	IVA
3020	Madera	Negro	90 mm	1 / 25	0,144 €	21
3022	Madera	Amarillo	90 mm	1 / 25	0,144 €	21
3020/P	Madera	Negro	80 mm	1 / 25	0,144 €	21
3022/P	Madera	Amarillo	80 mm	1 / 25	0,144 €	21



3020



3020/P



3022



3022/P



Aislador para hilo

Ref.	Poste	Color	Long.		PVP	IVA
3010	Metal	Negro	35 mm	1 / 25	0,330 €	21
3012	Metal	Negro	80mm	1 / 25	0,690 €	21



3010



3012



Aislador para hilo

Ref.	Poste	Long.		PVP	IVA
3021	Madera	22 cm	1 / 10	0,690 €	21



Aislador para hilo de pomo

- Clavo no incluido

Ref.	Poste		PVP	IVA
3030	Madera	1 / 100	0,089 €	21



Aislador para hilo

Ref.	Color	Poste		PVP	IVA
3060/F	Negro	Varilla Ø 12 mm	1 / 25	0,191 €	21
3060/N	Negro	Varilla Ø 19 mm	1 / 25	0,191 €	21
3060	Amarillo	Varilla Ø 19 mm	1 / 25	0,191 €	21



Aislador para hilo

Ref.	Poste		PVP	IVA
3055	Madera	1 / 10	0,298 €	21



Aislador para hilo en esquina

- Colocación sencilla

Ref.	Poste		PVP	IVA
3008	Madera	1 / 10	0,890 €	21



Aislador para hilo en esquina

Ref.	Poste		PVP	IVA
3007	Madera	1 / 25	0,679 €	21



Aislador para hilo de esquina

Ref.	Color		PVP	IVA
3056	Negro	1 / 25	0,380 €	21
3024	Blanco	1 / 25	0,380 €	21



Aislador para hilo "cola de cerdo"

Ref.	Poste	Long.	PVP	IVA
3011	Madera	8 cm	1,790 €	21
3018	Madera	25 cm	1,950 €	21
3019	Madera	40 cm	2,150 €	21
3014	Fibra vidrio Ø 12 mm	10 cm	0,350 €	21



3014

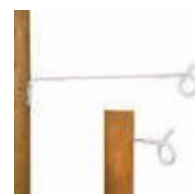

3011 - 3018 - 3019

Aislador para hilo / cinta 20 mm

Ref.	Poste		PVP	IVA
3020/HC	Madera	1 / 25	0,219 €	21



3025



3025/CV



3025/PM



3025/PF



Aislador para hilo / cinta 40 mm

Ref.	Poste		PVP	IVA
3025	Madera	1 / 25	0,294 €	21
3025/CV	Madera	1 / 25	0,282 €	21
3025/PM	Metal	1 / 25	0,498 €	21
3025/PF	Fibra vidrio Ø 12 mm	1 / 25	0,375 €	21

Aislador para cinta 20 mm

Ref.	Poste		PVP	IVA
3005	Madera	1 / 25	0,290 €	21



Aislador para cinta 20 mm

Ref.	Poste	Long.		PVP	IVA
3023	Madera	22 cm	1 / 10	0,850 €	21



Aislador para cinta 20 mm

Ref.	Poste	Long.		PVP	IVA
3061	Madera	20 cm	1 / 10	0,890 €	21
3061/M	Metal	20 cm	1 / 10	1,150 €	21



3061



3061/M



Aislador para cinta 40 mm

Ref.	Poste		PVP	IVA
3003	Fibra vidrio Ø 17 mm	1 / 10	0,390 €	21



Aislador de esquina para cinta 40 mm

Ref.	Poste		PVP	IVA
3066	Madera	1 / 10	1,890 €	21



Aislador doble de esquina para cinta 40 mm

Ref.	Poste		PVP	IVA
3067	Madera	1 / 10	2,100 €	21



Aislador para cinta

Ref.	Poste	Cinta		PVP	IVA
3052	Madera	20 mm	1 / 10	0,315 €	21
3050	Madera	40 mm	1 / 10	0,335 €	21



Aislador para cinta

Ref.	Poste		PVP	IVA
3054	Madera	1 / 10	1,590 €	21



Aislador para cinta 40 mm "cola de cerdo"

Ref.	Poste		PVP	IVA
3016	Fibra vidrio Ø 19 mm	1 / 25	0,490 €	21



Rácor de unión para hilo

Ref.	Modelo	Ø hilo	PVP	IVA
3096	Cromado	6 mm	0,790 €	21
3092	Cromado	8 mm	1,420 €	21
3098	Acero inox	6 mm	2,250 €	21
3094	Acero inox	8 mm	3,350 €	21



Abrazadera para aisladores

Ref.	Poste	PVP	IVA
3071	Metal Ø 35-70 mm	2,250 €	21



Tensor para hilo

Ref.	PVP	IVA
3065	3,150 €	21



Rácor galvanizado de unión para hilo / cinta

Ref.	Cinta	PVP	IVA
3090	12,5 mm	0,450 €	21
3080	20 mm	0,490 €	21
3075	40 mm	0,590 €	21



Rácor de unión para cinta 40 mm

- Ideal para usar con aislador 3054

Ref.	PVP	IVA
3085	1,290 €	21



Tensor para cinta

Ref.	Cinta	PVP	IVA
3068	20 mm	12,900 €	21
3069	40 mm	13,900 €	21



Grapa

Ref.	Medida	Cant.	PVP	IVA
3062	30 x 3,4 mm	50	2,350 €	21



Placas de señalización

Ref.	Medidas	Material	PVP	IVA
3256	33 x 19,5 cm	Aluminio	9,550 €	21
3257	34,5 x 24,5 cm	PVC	6,350 €	21
3258	17 x 11 cm	PVC	2,290 €	21



Tenaza para cercados

- Apta para cables de hasta Ø 5 mm

Ref.	PVP	IVA
3163	11,950 €	21



Adaptador para taladro

- Específico para colocación de aisladores

Ref.	PVP	IVA
3081	4,950 €	21



Interruptor de corriente para cercado eléctrico

- Permite la gestión de 2 cercados distintos

Ref.	PVP	IVA
2947	8,950 €	21



Derivador de rayos

Ref.	PVP	IVA
3265	24,950 €	21



Trampa PVC para topos

- Longitud regulable
- 2 entradas, con orificios de control

Ref.	Longitud	PVP	IVA
10261	25,5 > 27,5 cm	3,950 €	21



Trampa PVC BlocBox para ratones y ratas

- Puede cerrarse con llave, para mantener el cebo fuera del alcance de los niños y las mascotas
- Aptas para cebo en bloque, cereales y pasta

Ref.	Medidas	PVP	IVA
10251	32,5 x 25 x 16 cm	10,250 €	21
10253	22,5 x 18 x 5,9 cm	6,950 €	21
10254	12,5 x 9 x 5,4 cm	1,490 €	21

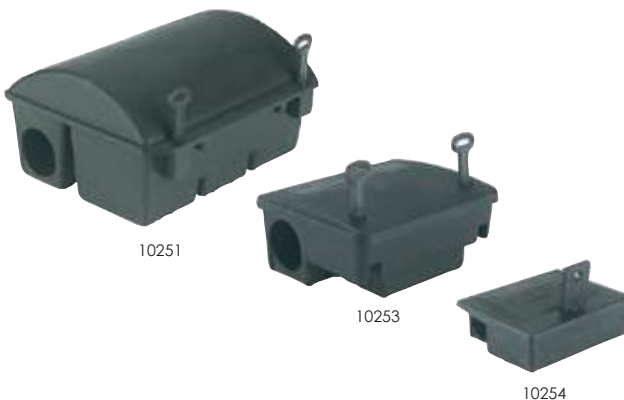

Trampa PVC para ratones y ratas

Ref.	Medidas	Uso	Cant.	PVP	IVA
10242	9 x 4,5 cm	Ratones	2	5,950 €	21
10244	18 x 9 cm	Ratas	1	9,950 €	21
10242/01	Cebo	10242	6	5,950 €	21
10244/01	Cebo	10244	3	9,950 €	21



10242/01 - 10244/01



Trampa PVC para ratones

Ref.	Medidas	PVP	IVA
10241	11 x 5 cm	3,950 €	21



Trampa madera para ratones y ratas

Ref.	Medidas	Uso	Cant.	PVP	IVA
10231	9,5 x 5 cm	Ratones	2	1,690 €	21
10233	16,5 x 8,5 cm	Ratas	1	2,290 €	21



Jaula de captura 1 puerta

Ref.	Medidas	PVP	IVA
10240	62 x 21 x 21 cm	33,950 €	21
10245	82 x 32 x 31 cm	53,950 €	21
10246	127 x 36 x 47 cm	96,950 €	21



Jaula de captura 2 puertas

Ref.	Medidas	PVP	IVA
10247	130 x 36 x 47 cm	124,950 €	21



Jaula de captura 2 puertas

- Entradas invisibles

Ref.	Medidas	PVP	IVA
10249	80 x 19 x 19 cm	27,950 €	21
10248	102 x 30 x 21 cm	69,950 €	21



Jaula de contención para gatos 1 puerta

- Hilo de acero plastificado
- Apertura superior para introducir al animal

Ref.	Longitud	PVP	IVA
10252	44 x 30 x 29 cm	119,950 €	21



Pinza de captura para gatos

Ref.	Longitud	PVP	IVA
13395	76 cm	89,980 €	21



Lazo con freno para perros

Ref.	Longitud	PVP	IVA
13385	100 cm	129,950 €	21
13390	150 cm	139,950 €	21



Exterminador de insectos

- Fabricado en plástico ABS

Ref.	Medidas	Potencia	Alcance	PVP	IVA
10832	40 x Ø 13 cm	1 x 11 W	20 m ²	33,950 €	21



Exterminador de insectos

- Fabricado en acero inox. AISI 304

Ref.	Medidas	Potencia	Alcance	PVP	IVA
10820	28 x 31 x 11 cm	2 x 11 W	100 m ²	129,950 €	21
10825	41 x 26 x 10,5 cm	2 x 15 W	125 m ²	149,950 €	21
10810	66 x 30,5 x 7 cm	2 x 20 W	160 m ²	210,950 €	21



10820



10825



10810

Exterminador de insectos Beaumont

- Fabricado en aluminio
- Cristal de seguridad

Ref.	Medidas	Potencia	Alcance	PVP	IVA
10801	50 x 26 x 8 cm	1 x 15 W	80 m ²	47,950 €	21
10802	50 x 26 x 8 cm	2 x 15 W	120 m ²	74,950 €	21



10801



10802

Exterminador de insectos Beaumont

- Fabricado en aluminio
- Cristal de seguridad

Ref.	Medidas	Potencia	Alcance	PVP	IVA
10803	65 x 36 x 8 cm	2 x 20 W	140 m ²	79,950 €	21
10804	65 x 36 x 8 cm	3 x 20 W	160 m ²	149,950 €	21



10803



10804

Exterminador de insectos Insectrap

- Idóneo para hostelería, funcional, estético y silencioso
- Funciona con films autoadhesivos 0,145m²intercambiables
- Instalación mural
- Acabado en acero inox.



Ref.	Medidas	Potencia	PVP	IVA
10827	88,5 x 16,5 x 10 cm	1 x 20 W	149,950 €	21
10827/R	Film de recambio		15,550 €	21

Exterminador de insectos mini

- Fácil de usar, basta con conectarlo a un enchufe
- Fabricado en plástico ABS



Ref.	Medidas	Potencia	PVP	IVA
10807	18 x 16 x 7 cm	1 x 4 W	16,500 €	21

Lámina atrapamoscas

- Alcance de 200 m² por lámina



Ref.	Medidas	Cant.	PVP	IVA
10840	59,5 x 30 cm	6	12,550 €	21

Cordón atrapamoscas

Ref.	Longitud	PVP	IVA
10848	150 m	12,800 €	21
10850	440 m	25,900 €	21



Rollo atrapamoscas

- Soporte de metal incluido

Ref.	Medidas	PVP	IVA
10845	7 m x 30 cm	11,950 €	21



Ambientador repelente de mosquitos

- * Aromas naturales: **Dakar**, **Lavanda**, **Limón**, **Loewe**, **Royal**

Ref.	Modelo	PVP	IVA
10860	Manual	24,950 €	21
10862	Automático	28,950 €	21
10890	Piretrina natural	6,950 €	21
10892	Piretrina sintética	5,950 €	21
10895	Ambientador natural *	5,950 €	21



Demotec 90

- Taco de madera

Ref.	Tratamientos	PVP	IVA
3502	2	24,950 €	21
3510	12	91,950 €	21
3513	42	238,950 €	21



Demotec 95

- Taco de madera

Ref.	Tratamientos	PVP	IVA
3512	14	101,950 €	21
3514	42	269,950 €	21



Demotec Easy Bloc

- Taco de plástico

Ref.	Tratamientos	PVP	IVA
3506	4	49,950 €	21
3505	12	104,950 €	21
3504	36	279,890 €	21



Demotec Easy Bloc Express

- Taco de plástico
- Secado más rápido

Ref.	Tratamientos	PVP	IVA
3505/E	12	104,950 €	21
3504/E	36	279,590 €	21



Technobase 8000

- Taco de madera

Ref.	Tratamientos	PVP	IVA
3515	14	84,950 €	21



Taco madera

Ref.	Modelo	PVP	IVA
3500	L	0,790 €	21
3500/XL	XL	1,490 €	21



Taco plástico Easy Bloc

Ref.	Modelo	Pata	PVP	IVA
3501/I	L	Izquierda	4,095 €	21
3501/D	L	Derecha	4,095 €	21
3503/I	XXL	Izquierda	5,100 €	21
3503/D	XXL	Derecha	5,100 €	21



Cartucho pegamento

Ref.	Modelo	Capac.	Pistola	PVP	IVA
3522	Easy Bond II	160 gr	3509	44,950 €	21
3550	Septicare	160 gr	3509	31,950 €	21
3552	Septicare XL	250 gr	3508	39,950 €	21



3522



3550



3552

Cánula mezcladora

Ref.	Modelo	Cant.	PVP	IVA
3525	Easy Bond II	10	7,400 €	21
3555	Septicare	10	8,950 €	21
3557	Septicare XL	10	8,950 €	21



3525 - 3555



3557

Pistola aplicadora

Ref.	Modelo	PVP	IVA
3509	Easy Bond II / Septicare	42,500 €	21
3508	Septicare XL	11,950 €	21



Tratamiento Shoof caballos

Ref.	Talla	Ø casco	PVP	IVA
3635	2	130 mm	37,890 €	21
3636	3	145 mm	37,890 €	21
3637	4	160 mm	37,890 €	21
3640	Zapato de recambio		4,980 €	21



Tratamiento Shoof vacas

Ref.	Talla	Color	Modelo	PVP	IVA
3615/AM	M	Amarillo	Derecho	39,950 €	21
3620/AM	M	Amarillo	Izquierdo	39,950 €	21
3625/AM	M	Amarillo	Estándar	39,950 €	21
3615/AZ	L	Azul	Derecho	39,950 €	21
3620/AZ	L	Azul	Izquierdo	39,950 €	21
3625/AZ	L	Azul	Estándar	39,950 €	21



Zapato protector cascos ovino

Ref.	PVP	IVA
3935	9,950 €	21



Spray Septiject

Ref.	Capac.	PVP	IVA
11905	500 cc	11,450 €	21



Spray de alquitrán

Ref.	Capac.	PVP	IVA
4130	200 cc	6,450 €	21



Venda de yute

Ref.	Long.	Ancho	PVP	IVA
4160	50 m	10 cm	13,950 €	10



Venda de alquitrán "Kromberg"

Ref.	Long.	Ancho	PVP	IVA
4110	25 m	4,5 cm	9,900 €	10



Alquitrán de haya

Ref.	Capac.	PVP	IVA
4120	1 Kg	5,950 €	21



Grasa para cascos

Ref.	Capac.	Color	PVP	IVA
4140	1 Kg	Negro	8,550 €	21
4145	1 Kg	Verde	8,750 €	21



Disco Tungsteno

Ref.	Ø	PVP	IVA
3720	115 mm	26,850 €	21
3725	125 mm	28,900 €	21



Disco Tungsteno Philipsen

Ref.	Ø	PVP	IVA
3721	115 mm	47,950 €	21



Disco abrasivo

Ref.	Ø	Modelo	PVP	IVA
3715	115 mm	Estándar	2,825 €	21



Disco aluminio

Ref.	Ø	Cuchillas	PVP	IVA
3733 *	98 mm	7	164,950 €	21
3733/01	Cuchillas repuesto (1 ud)		17,950 €	21
3728	120 mm	3	149,950 €	21
3726	120 mm	6	188,950 €	21
3728/01	Cuchillas repuesto (3 uds)		49,900 €	21



3733



3726 - 3728

* Hauptner

Disco tungsteno carbide P6

Ref.	Ø	Cuchillas	PVP	IVA
3735	105 mm	6	94,950 €	21
3740	125 mm	6	106,950 €	21



3735



3740

Disco Rotoclip

Ref.	Ø	Cuchillas	PVP	IVA
3734	115 mm	6 curvas	409,950 €	21
3734/01	Cuchillas repuesto (6 uds)		109,950 €	21
3724	115 mm	6 planas	409,950 €	21
3724/01	Cuchillas repuesto (6 uds)		109,950 €	21



3734



3724

Máquina para discos

Ref.	PVP	IVA
3710	169,950 €	21



Herradura

Ref.	Modelo	Pestañas	Nº	PVP	IVA
3601/0	Pata	0	0	2,250 €	21
3601/1	Pata	0	1	2,250 €	21
3601/2	Pata	0	2	2,250 €	21
3601/3	Pata	0	3	2,250 €	21
3601/4	Pata	0	4	2,250 €	21
3601/5	Pata	0	5	2,250 €	21
3603/1	Pata	1	1	2,250 €	21
3603/2	Pata	1	2	2,250 €	21
3603/3	Pata	1	3	2,250 €	21
3603/4	Pata	1	4	2,250 €	21
3603/5	Pata	1	5	2,250 €	21
3605/1	Pata	2	1	2,250 €	21
3605/2	Pata	2	2	2,250 €	21
3605/3	Pata	2	3	2,250 €	21
3605/4	Pata	2	4	2,250 €	21
3605/5	Pata	2	5	2,250 €	21
3607/0	Mano	0	0	2,250 €	21
3607/1	Mano	0	1	2,250 €	21
3607/2	Mano	0	2	2,250 €	21
3607/3	Mano	0	3	2,250 €	21
3607/4	Mano	0	4	2,250 €	21
3607/5	Mano	0	5	2,250 €	21
3609/1	Mano	1	1	2,250 €	21
3609/2	Mano	1	2	2,250 €	21
3609/3	Mano	1	3	2,250 €	21
3609/4	Mano	1	4	2,250 €	21
3609/5	Mano	1	5	2,250 €	21
3602	Pata	Vacuno	4	3,650 €	21
3606	Mano	Vacuno	4	3,650 €	21



3601 - 3607



3603 - 3609



3605



3602 - 3606

Clavo para herradura

Ref.	Nº	Cant.	PVP	IVA
3611/100	1	100	7,950 €	21
3611	1	500	33,950 €	21
3612/100	2	100	7,950 €	21
3612	2	500	33,950 €	21



Vidia

Ref.	Cant.	PVP	IVA
3618	100	42,950 €	21



Tenaza de talón para cascos y herrar

Ref.	Long.	PVP	IVA
3830	30 cm	64,950 €	21



Tenaza de corte y desherrar

Ref.	Long.	PVP	IVA
3811	30 cm	45,950 €	21



Tenaza articulada

Ref.	Long.	PVP	IVA
3730	42 cm	29,800 €	21



Tenaza para cascos con dientes

Ref.	Long.	PVP	IVA
3840	31 cm	15,900 €	21



Tenaza cocodrilo para herrar

Ref.	Long.	PVP	IVA
3813	35 cm	18,950 €	21



Rascador

Ref.	Long.	PVP	IVA
3860	18 cm	1,390 €	21
3865	14 cm	1,190 €	21



3865



3860

Lima para cascós

Ref.	Long.	PVP	IVA
3805	20 cm	22,950 €	21
3815	30 cm	36,950 €	21



Escofina curva para cascós

Ref.	Long.	PVP	IVA
3745	30 cm	11,700 €	21



Afilador de diamante

Ref.	Long.	PVP	IVA
3800	31 cm	33,950 €	21



Afilador Sharpener

Ref.	Long.	PVP	IVA
4170	12,5 cm	25,950 €	21



Piedra para afilar legbras

Ref.	Long.	PVP	IVA
4150	10 cm	4,650 €	21



Martillo

Ref.	Long.	PVP	IVA
3819	33 cm	14,950 €	21
3824	33 cm	13,890 €	21



3819



3824

Maza para herrar

Ref.	Long.	PVP	IVA
3821	30 cm	15,900 €	21



Tijera de aluminio para cascos de ovino

- Filo serrado

Ref.	PVP	IVA
3940	11,900 €	21



Tijera para cascos de ovino

Ref.	Lámina	PVP	IVA
3950	Corta	10,900 €	21
3960	Larga	11,900 €	21



Tijera para cascos de ovino

- Mango reforzado

Ref.	PVP	IVA
3970	67,950 €	21



Tijera neumática para cascos de ovino

- Mango reforzado

Ref.	PVP	IVA
3980	288,800 €	21



Cuchilla para cascos

Ref.	Long.	PVP	IVA
4060	30 cm	7,950 €	21
3817	37 cm	22,950 €	21

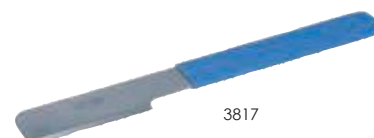

Pujavante

Ref.	Modelo	Long.	PVP	IVA
3910	Recto	16 cm	4,990 €	21
3920	Curvo	16 cm	4,990 €	21
3915	Herrador	18 cm	18,950 €	21



Legra

Ref.	Corte	Calidad	PVP	IVA
4012	Derecho	Aesculap 302	19,950 €	21
4015	Derecho	A	14,950 €	21
4010	Derecho	B	3,500 €	21
4022	Izquierdo	Aesculap 307	19,950 €	21
4025	Izquierdo	A	14,950 €	21
4020	Izquierdo	B	3,500 €	21
4034	Doble	Aesculap 316	21,950 €	21
4035	Doble	A	16,250 €	21
4030	Doble	B	3,500 €	21



Legra estrecha

Ref.	Corte	Calidad	PVP	IVA
4043	Derecho	Aesculap 300	19,950 €	21
4042	Derecho	A	14,950 €	21
4040	Derecho	B	3,500 €	21
4047	Izquierdo	Aesculap 305	19,950 €	21
4046	Izquierdo	A	14,950 €	21
4045	Izquierdo	B	3,500 €	21
4033	Doble	Aesculap 315	21,950 €	21
4050	Doble	B	3,500 €	21



Legra estrecha mango de ébano

Ref.	Calidad	PVP	IVA
4041/D	Aesculap 310	32,890 €	21
4041/I	Aesculap 311	32,890 €	21



Cuchillo para cascos

Ref.	Long.	PVP	IVA
4055	18 cm	4,950 €	21



Legra para ovino

Ref.	Long.	PVP	IVA
4065	14 cm	4,950 €	21



Abrebocas Schulze

- Mango de madera
- Para vacuno y equino

Ref.	PVP	IVA
4435	16,950 €	21



Abrebocas Schoupe

- Para equino

Ref.	PVP	IVA
4430	16,950 €	21



Abrebocas Bayer

- Para vacuno y equino

Ref.	PVP	IVA
4420	16,950 €	21



Abrebocas Günter

- Para equino
- Muy útil para usar con sondas endotraqueales

Ref.	Calidad	PVP	IVA
4410	A	299,950 €	21
4415	B	58,980 €	21



Raspador dental

- Para equino
- Mango de goma
- Raspador de tungsteno recambiable

Ref.	Descripción	PVP	IVA
4440	Raspador con mango	109,950 €	21
4455	Raspador de recambio	49,950 €	21



Lima eléctrica

- Para equino
- Cabezal Ø 22 mm
- Permite llegar a las partes más complicadas de la cavidad bucal

Ref.	PVP	IVA
4460	2.195,890 €	21



Alicate cortacolmillos

Ref.	Tipo	PVP	IVA
6560	1	5,950 €	21
6570	2	5,950 €	21



6560



6570

Lima eléctrica a red 220V

- Para porcino
- Regulador de velocidad
- Incluye muela y tapa protectora de aluminio

Ref.	Descripción	PVP	IVA
6528	Lima eléctrica a red	203,950 €	21
6528/04	Muela de recambio Ø 7 mm	26,950 €	21



Lima eléctrica a red 220V con eje flexible

- Para porcino
- Regulador de velocidad
- Longitud 100 cm
- Incluye muela, tapa protectora de aluminio y soporte con mosquetón

Ref.	Descripción	PVP	IVA
6530	Lima eléctrica con eje flexible	249,850 €	21
6528/04	Muela de recambio Ø 7 mm	26,950 €	21



Lima eléctrica a batería

- Para porcino
- Regulador de velocidad
- Batería 12V 2Ah
- Tiempo de carga: 1 hora
- Incluye muela, tapa protectora de aluminio, batería y cargador

Ref.	Descripción	PVP	IVA
6525	Lima eléctrica a batería	279,850 €	21
6528/04	Muela de recambio Ø 7 mm	26,950 €	21



Descornador eléctrico a red

- Boquilla Ø 18 mm
- Ligero y ergónomico
- Temperatura máxima 620 °C
- Longitud cable: 3 m



Ref.	Descripción	PVP	IVA
5145	Descornador	69,890 €	21
5147	Boquilla 15 mm	8,950 €	21
5146	Boquilla 18 mm	8,950 €	21



5147



5146

Descornador eléctrico a red con transformador de seguridad

- Boquilla Ø 18 mm
- Temperatura máxima 620 °C
- Longitud cable: 4 m
- Transformador de seguridad 24V



Ref.	PVP	IVA
5140/T	209,950 €	21

Descornador a gas

- Temperatura máxima 600 °C
- Mantenimiento y uso sencillo
- Botella de gas no incluida

Ref.	PVP	IVA
5210	160,950 €	21



Descornador eléctrico a batería Buddex

- Temperatura máxima 700 °C
- Incluye cargador 220V y cargador 12V para coche

Ref.	PVP	IVA
5170	235,950 €	21



Descornadora eléctrica de sierra a red

- 2.400 W
- Indicada para ganado adulto
- Incluye sierra de 22 cm

Ref.	Descripción	PVP	IVA
5110	Descornadora	752,900 €	21
5120	Sierra Ø 22 cm	59,950 €	21



5120



Guía para cuernos

Ref.	PVP	IVA
5260	28,380 €	21



Pasta para descornar

- Para terneros de hasta 2-3 semanas
- Uso para 24 terneros aproximados

Ref.	PVP	IVA
5220	8,950 €	21



Lapiz de sosa

- Para terneros entre 1-4 semanas
- Uso para 4-6 terneros aproximados

Ref.	PVP	IVA
5225	5,690 €	21



Sirga para descornar

Ref.	Long.	PVP	IVA
5230	12 m	4,990 €	21



Sirga para descornar Bovivet

Ref.	Long.	PVP	IVA
5240	3,6 m	6,690 €	21



Mango sujecion de sirga para descornar

Ref.	Cant.	PVP	IVA
5250	2	4,950 €	21



Tenaza para cuernos Fiskars

Ref.	Long.	PVP	IVA
5270	80 cm	93,950 €	21



Cortacuernos

- Uso para ternemos de menos de 2 meses

Ref.	Mango	Long.	PVP	IVA
5180	Madera	32 cm	14,950 €	21
5180/13	Metal	32 cm	17,950 €	21
5180/17	Metal	42 cm	19,950 €	21



Emasculador Hausmann recto

Ref.	Long.	Calidad	PVP	IVA
9410	19 cm	A	79,950 €	21
9412	19 cm	B	19,950 €	21
9418	27 cm	A	93,950 €	21
9420	27 cm	B	26,950 €	21
9422	33 cm	A	105,950 €	21
9423	33 cm	B	29,950 €	21



Emasculador Hausmann curvo

Ref.	Long.	Calidad	PVP	IVA
9430	19 cm	A	73,950 €	21
9432	19 cm	B	19,950 €	21
9438	27 cm	A	94,950 €	21
9440	27 cm	B	26,950 €	21
9445	33 cm	A	106,950 €	21
9448	33 cm	B	29,950 €	21



Emasculador Verboczy equino

Ref.	Long.	Calidad	PVP	IVA
9450	31 cm	A	159,950 €	21
9452	31 cm	B	49,950 €	21



Emasculador Reimers equino

Ref.	Long.	Calidad	PVP	IVA
9468/H	30 cm	Hauptner	799,950 €	21
9465	30 cm	A	205,950 €	21
9460	30 cm	B	75,900 €	21



Emasculador Sand-Serra equino

Ref.	Long.	Calidad	PVP	IVA
9474/H	36 cm	Hauptner	649,950 €	21
9470	31 cm	A	143,950 €	21
9472	31 cm	B	54,950 €	21

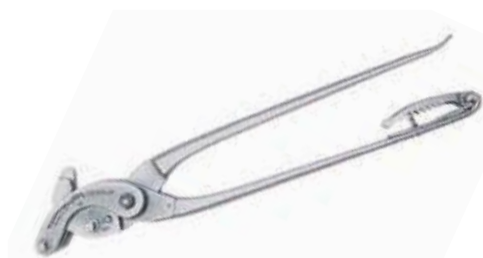

Burdizo articulado

Ref.	Long.	Calidad	PVP	IVA
9330	36 cm	A	189,950 €	21
9345	36 cm	B	36,950 €	21
9335	40 cm	A	214,950 €	21
9350	40 cm	B	44,900 €	21
9340	48 cm	A	219,950 €	21
9355	48 cm	B	49,900 €	21



Burdizo articulado para ovino

Ref.	Long.	Calidad	PVP	IVA
9360	23 cm	B	24,800 €	21



Elastrator

Ref.	Calidad	PVP	IVA
9310	A	7,950 €	21
9312	B	4,950 €	21



Gomas de caucho

Ref.	Cant.	PVP	IVA
9325	100	2,200 €	21
9320	500	10,950 €	21



Potro castrador para lechones

- Usar con lechones de 2-9 días
- Soporte incluido

Ref.	PVP	IVA
6535	124,950 €	21



Potro estándar para lechones

Ref.	PVP	IVA
6554	79,900 €	21



Cortacolas a gas

- Uso en lechones de 3-4 días
- Incluye un spray de gas

Ref.	Descripción	PVP	IVA
9520	Cortacolas	60,950 €	21
9540	Punta de recambio	13,900 €	21
9550	Cartucho de recambio	26,900 €	21
9570	Spray de gas 200 cc	3,950 €	21



9570



9520



9550



9540

Cortacolas eléctrico Engel recto

- Corta y cauteriza al mismo tiempo

Ref.	Descripción	PVP	IVA
9510	Cortacolas Engel recto	118,950 €	21
9510/01	Cuchilla de recambio	23,950 €	21



9510/01



Cortacolas eléctrico Engel curvo con horquilla

- Corta y cauteriza al mismo tiempo
- La horquilla especial sirve para agarrar el rabo

Ref.	Descripción	PVP	IVA
9512	Cortacolas Engel curvo	171,950 €	21
9512/01	Cuchilla de recambio	23,950 €	21



9512/01



Cortacolas eléctrico Engel manos libres con transformador

- Corta y cauteriza al mismo tiempo
- Incl. distanciador regulable para cortar los rabos a la misma longitud

Ref.	Descripción	PVP	IVA
9517	Cortacolas Engel m.l.	132,950 €	21
9517/01	Cuchilla de recambio	23,950 €	21
9518	Soporte	17,950 €	21



9517/01



9518



Tijera recta para esquilar ovino

Ref.	Long.	PVP	IVA
9710	34 cm	9,550 €	21



Tijera curva para esquilar ovino

Ref.	Long.	PVP	IVA
9720	29 cm	9,550 €	21



Esquiladora manual para esquilar

Ref.	Ganado	Long.	Calidad	PVP	IVA
9660	Vacuno	25,5 cm	B	23,950 €	21
9650	Ovino	27,5 cm	B	23,950 €	21
9760	Ovino	26,5 cm	Hauptner	78,950 €	21



Esquiladora manual mini

Ref.	Nº	Long.	PVP	IVA
9740	0	14 cm	9,950 €	21
9741	1	14 cm	9,950 €	21
9742	2	14 cm	9,950 €	21



Tijera curva para crines

Ref.	Long.	PVP	IVA
9730	17 cm	5,490 €	21
9735	21 cm	6,950 €	21



Esquiladora eléctrica Constanta 4 vacuno / equino a red

- Vacuno: 400 W 50 Hz / Equino: 120 W 50 Hz
- Vacuno: 2.400 r.p.m. / Equino: 2.300 r.p.m.
- Vacuno: 87 dB / Equino: 78 dB
- Vacuno: Peso: 1.490 gr / Equino: 1.390 gr
- Incluye peine y cuchilla



Ref.	Ganado	Peine / Cuchilla	PVP	IVA
9810	Vacuno	21 / 23	399,950 €	21
9815	Equino	31 / 15	399,950 €	21

Cuchilla Constanta / Rodeo para vacuno / equino

Ref.	Constanta	Dientes	Ganado	PVP	IVA
9820	1 - 2	19	Vacuno	24,900 €	21
9825	1 - 2	24	Vacuno	24,900 €	21
9828	1 - 2	24	Equino	24,900 €	21
9851	3 - 4	15	Vacuno / Equino	26,900 €	21
9856	3 - 4	23	Equino	26,900 €	21



Constanta 1-2



Constanta 3-4

Peine Constanta / Rodeo para vacuno / equino

Ref.	Constanta	Dientes	Ganado	PVP	IVA
9830	1 - 2	18	Vacuno	26,900 €	21
9835	1 - 2	21	Vacuno	26,900 €	21
9838	1 - 2	35	Equino	26,900 €	21
9859	3 - 4	31	Vacuno / Equino	28,900 €	21
9862	3 - 4	21	Vacuno	30,900 €	21



Constanta 1-2



Constanta 3-4

Esquiladora eléctrica Hauptner vacuno / equino a red

- 180 W

Ref.	PVP	IVA
10010	419,900 €	21



Cuchilla Hauptner vacuno / equino

Ref.	Dientes	Ganado	PVP	IVA
10080	17	Vacuno	29,950 €	21
10085	22	Equino	29,950 €	21



10080



10085

Peine Hauptner vacuno / equino

Ref.	Dientes	Ganado	PVP	IVA
10070	24	Vacuno	32,950 €	21
10075	35	Equino	32,950 €	21



10070



10075

Esquiladora eléctrica Heineger Xplorer vacuno inalámbrica

- 250 W
- 2.450 r.p.m.
- 65 dB
- Peso: 990 gr
- Incluye 1 batería + juego de peine y cuchilla 21/23



Ref.	PVP	IVA
10150	535,950 €	21

Cuchilla Heineger Xplorer

Ref.	Dientes	PVP	IVA
10151	15	22,950 €	21
10161	23	22,950 €	21



10151



10161

Peine Heineger Xplorer

Ref.	Dientes	PVP	IVA
10158	21	29,950 €	21
10160	31	29,950 €	21



10158



10160

Accesorios Heineger inalámbricas

Ref.	Descripción	Modelo	PVP	IVA
10156	Batería recargable	Xplorer	119,950 €	21
10157	Cargador batería	Xplorer	125,950 €	21
10122	Batería recargable	Cordless	119,950 €	21
10120	Cargador batería	Cordless	110,950 €	21



10156



10157



10122



10120

Esquiladora eléctrica ovino

- Motor colgante
- Brazo flexible

Ref.	Velocidad	Potencia	PVP	IVA
10060	Fija 2.800 r.p.m.	250 W	1.209,900 €	21
10065	Variable 2.000 - 4.000 r.p.m.	368 W	1.790,000 €	21



Esquiladora eléctrica Constanta 4 ovino a red

- 400 W 50 Hz
- 2.400 r.p.m.
- 87 dB
- Peso: 1.510 gr

Ref.	PVP	IVA
9910	399,950 €	21



Cuchilla Constanta ovino

Ref.	Dientes	PVP	IVA
9920	4	7,250 €	21



Peine Constanta ovino

Ref.	Dientes	Altura corte	PVP	IVA
9950	13	3 mm	33,950 €	21
9930	13	5 mm	26,950 €	21
9940	13	5 mm	33,950 €	21



9950



9930



9940

Esquiladora eléctrica Hauptner ovino a red

- 180 W
- 4.700 r.p.m.

Ref.	PVP	IVA
10040	429,950 €	21



Cuchilla Hauptner ovino

Ref.	Dientes	PVP	IVA
10045	4	25,950 €	21



Peine Hauptner ovino

Ref.	Dientes	PVP	IVA
10048	13	47,950 €	21
10090	18	40,950 €	21



10048



10090

Esquiladora eléctrica Heineger Xtra ovino a red

- 320 W
- 2.400 r.p.m.
- 80 dB
- 1.530 gr



Ref.	PVP	IVA
10115	520,950 €	21

Cuchilla Heineger ovino

Ref.	Dientes	PVP	IVA
10140	4	8,900 €	21



Peine Heineger ovino

Ref.	Dientes	Anchura	Altura corte	PVP	IVA
10118	13	77 mm	5,5 mm	32,950 €	21



Peine Heineger ovino

- Ideal para sacar el máximo rendimiento en lanas sucias y densas
- Específica para diestros

Ref.	Dientes	Anchura	Altura corte	PVP	IVA
10119	13	93,5 mm	3,5 mm	34,950 €	21



Esquiladora eléctrica Heineger Saphir equino / canino inalámbrica

- 35 W
- 2.650 r.p.m.
- 50 dB
- 440 gr
- Incluye 2 baterías + 1 peine 1,8 mm
- Los cabezales son compatibles con los de la esquiladora Oster A5



Ref.	PVP	IVA
10055	399,980 €	21

Accesorios Heiniger Saphir

Ref.	Descripción	PVP	IVA
10056	Batería recargable	65,890 €	21
10057	Cargador batería	69,890 €	21



10056



10057

Esquiladora eléctrica Oster Power Pro equino inalámbrica

- 45 W
- 3.300 r.p.m.
- Incluye 1 batería + 1 peine nº10 ancho 2,4 mm (ref. 13134)
- Compatible con todos las cuchillas Cryogen-X

Ref.	PVP	IVA
10031	355,950 €	21



Accesorios Oster Power Pro

Ref.	Descripción	PVP	IVA
10035	Batería recargable	114,950 €	21
10035/R	Adaptador a red	99,950 €	21



Esquiladora eléctrica Oster Golden A5 canino a red

- 45 W
- 2 velocidades (2.200 r.p.m. / 3.300 r.p.m.)
- 500 gr
- Compatible con todos las cuchillas Cryogen-X
- **Cuchillas no incluidas**

Ref.	PVP	IVA
13105	189,950 €	21



Esquiladora eléctrica Oster A6 Slim canino a red

- 15 W
- 3 velocidades (3.100 / 3.600 / 4.100 r.p.m.)
- 370 gr
- Longitud cable: 3,66 m
- Compatible con todos las cuchillas Cryogen-X
- **Cuchillas no incluidos**

Ref.	PVP	IVA
13180	239,950 €	21



Esquiladora eléctrica Oster Mini Trimmer canino inalámbrica

- Silenciosa, ligera y compacta (17.4 x 11.2 x 6.2 cm)
- 222 gr
- Incluye un peine acoplable para cortes más largos, un peine, un cepillo de limpieza y aceite de mantenimiento
- Pila (AA/LR6) no incluida

Ref.	PVP	IVA
87057	16,950 €	21



Esquiladora eléctrica Sonic canino inalámbrica

- Se puede conectar a la red con el cable de carga
- Altura de corte regulable en 5 niveles (0,8 - 2,0 mm)
- Incluye batería y 4 recalces para alturas de 3, 6, 9 y 12 mm
- Específica para el corte de precisión



Ref.	PVP	IVA
13195	52,810 €	21

Cuchillas Oster Cryogen-X

- Compatibles con:
 - Golden A5
 - A6
 - PowerPro Ultra
 - PRO3000i

Ref.	Tamaño	Corte	PVP	IVA
13100	50	0,2 mm	32,950 €	21
13110	40	0,25 mm	32,950 €	21
13112	30	0,5 mm	32,950 €	21
13116	10	1,6 mm	32,950 €	21
13118	7	3,2 mm	32,950 €	21
13122	5	6,3 mm	41,950 €	21
13126	5/8	0,8 mm	39,950 €	21
13128	7/8	0,8 mm	43,950 €	21
13121	4	9,5 mm	52,950 €	21
13132	8 1/2	2,8 mm	38,950 €	21
13120	7F	3,2 mm	36,950 €	21
13124	5F	6,3 mm	48,950 €	21
13114	9	2 mm	35,950 €	21
13134	10 ancho	2,4 mm	51,950 €	21



Recalce Oster

- Compatibles con cualquier cuchilla Oster Cryogen-X (excepto wide 10)

Ref.	Corte	PVP	IVA
13141	4 mm	6,900 €	21
13140	8 mm	6,900 €	21
13142	18 mm	6,900 €	21
13144	32 mm	7,900 €	21



Rasuradora desechable

Ref.	Cant.	PVP	IVA
13155	100	20,950 €	21



Afiladora eléctrica para cuchillas y peines

Ref.	PVP	IVA
9890	749,950 €	21



Polvo para afilado

Ref.	Cant.	PVP	IVA
9875	200 gr	8,950 €	21



Aceite lubricante para esquiladoras eléctricas

Ref.	Cant.	PVP	IVA
9880	80 ml	2,250 €	21



Spray para esquiladoras eléctricas

Ref.	Modelo	Cant.	PVP	IVA
9885	Refrigerante	500 ml	11,950 €	21
9886	Lubricante	400 ml	7,950 €	21



9885



9886

Grasa Oster para esquiladoras eléctricas

Ref.	Cant.	PVP	IVA
13190	35,4 gr	4,860 €	21



Pela colas para taladro

- Compatible con taladros de > 14 V (taladro no incluido)
- Engrasar y afilar cuchillas cada 1.000 rabos

Ref.	PVP	IVA
9770	505,890 €	21



Traba americana

Ref.	PVP	IVA
4710	95,950 €	21



Traba evitacoces

Ref.	Descripción	PVP	IVA
4720	Traba	8,150 €	21
4721	Taco de recambio	0,690 €	21
4722	Muelle de recambio	0,620 €	21



4721



4722



Elevador de vacas

Ref.	Peso máx.	PVP	IVA
5920	800 Kg	89,950 €	21
5921	1.500 Kg	158,890 €	21



5920



5921

Elevador de tela para vacas

Ref.	Peso máx.	PVP	IVA
5925	1.000 Kg	369,900 €	21



Elevador de cabeza para vacas

Ref.	PVP	IVA
5930	170,950 €	21



Elevador de patas para vacas

Ref.	PVP	IVA
5935	279,950 €	21



Bandeja guía porcino

Ref.	Medidas	PVP	IVA
5495	94 x 76 cm	38,450 €	21
5490	120 x 76 cm	47,890 €	21



Paleta arreadora porcino

Ref.	Long.	PVP	IVA
5480	50 cm	14,950 €	21
5485	107 cm	14,950 €	21



Empujador eléctrico Kawe

- Pilas: 1,5V x 2 (no incluidas)
- Sin desconexión automática

Ref.	PVP	IVA
5330	65,950 €	21



Empujador eléctrico Kawe 21

- Pilas: 1,5V x 2 (no incluidas)
- Desconexión automática

Ref.	PVP	IVA
5333	109,890 €	21



Alargador empujadores eléctricos Kawe

Ref.	Long.	PVP	IVA
5340	76 cm	25,950 €	21



Empujador eléctrico Plyrap

Pila: Hr20 x4 (recargable o estándar)

Ref.	Barra	PVP	IVA
5450	35 cm	49,950 €	21
5451	60 cm	52,950 €	21
5452	100 cm	55,950 €	21
5457	Cargador	55,950 €	21



Empujador eléctrico Little Shocker

- Pilas: AA x4 (incluidas)

Ref.	PVP	IVA
5303	25,950 €	21



Empujador eléctrico Hauptner

- Pila no incluida

Ref.	PVP	IVA
5370	55,950 €	21



Empujador eléctrico Hot-Shot Power Mite

- Pilas: 9V x 2 (incluidas)

Ref.	PVP	IVA
5360	83,950 €	21



Empujador eléctrico Torero

- Pila: 4,5V x 1 (incluida)
- Sin desconexión automática

Ref.	PVP	IVA
5350	22,950 €	21



Empujador eléctrico Torero 2.000

- Pila: 4,5V x 1 (incluida)
- Desconexión automática

Ref.	PVP	IVA
5365	28,90 €	21



Empujador eléctrico Hot-Shot verde con barra

- Funciona con pilas LR14 1,5V (x6) ó batería recargable (no incluidas)

Ref.	Barra	PVP	IVA
5415	34 cm	116,950 €	21
5420	60 cm	123,950 €	21
5430	85 cm	129,950 €	21
5435	110 cm	134,950 €	21



Empujador eléctrico Hot-Shot rojo con barra

- Funciona con pilas LR14 1,5V (x6) ó batería recargable (no incluidas)

Ref.	Barra	PVP	IVA
5434	34 cm	85,950 €	21
5436	60 cm	89,950 €	21
5438	85 cm	95,950 €	21
5439	110 cm	99,950 €	21



Mango empujador eléctrico Hot-Shot con motor

- Funciona con pilas LR14 1,5V (x6) ó batería recargable (no incluidas)

Ref.	Modelo	PVP	IVA
5432	Verde	107,950 €	21
5433	Rojo	73,950 €	21



Barra flexible empujador eléctrico Hot-Shot

Ref.	Long.	PVP	IVA
5401	34 cm	24,950 €	21
5405	60 cm	30,950 €	21
5407	85 cm	35,950 €	21
5409	110 cm	39,950 €	21



Barra rígida empujador eléctrico Hot-Shot

Ref.	Long.	PVP	IVA
5411	130 cm	30,950 €	21
5413	160 cm	34,950 €	21



Pila LR14 empujador eléctrico Hot-Shot verde / rojo

Ref.	Marca	Cant.	PVP	IVA
5470	Hot-Shot	6	10,950 €	21
5470/E	Panasonic	4	5,950 €	21

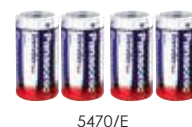

Batería recargable empujador eléctrico Hot-Shot verde / rojo

Ref.	Descripción	PVP	IVA
5431/B	Batería recargable	110,950 €	21
5431/M	Cargador mechero 12V	26,800 €	21
5431/C	Cargador a red 220V	26,800 €	21



Empujador eléctrico recargable Hot-Shot con barra

- Batería recargable incluida
- Cargador no incluido

Ref.	Barra	PVP	IVA
5445/60	60 cm	215,950 €	21
5445/B	Batería de recambio	138,950 €	21
5445/C	Cargador + base	99,950 €	21



Mango empujador eléctrico Sharp Shock

- Funciona con pilas LR14 1,5V (x4) ó batería recargable (no incluidas)

Ref.	PVP	IVA
5300	46,200 €	21



Barra flexible empujador eléctrico Sharp Shock

Ref.	Barra	PVP	IVA
5300/33	33 cm	11,450 €	21
5300/58	58 cm	14,450 €	21
5300/84	84 cm	18,450 €	21
5300/110	110 cm	24,950 €	21



Batería recargable empujador eléctrico Sharp Shock

Ref.	Descripción	PVP	IVA
5300/B	Batería recargable	39,950 €	21
5300/C	Cargador mechero 12V	16,950 €	21
5300/R	Cargador a red 220V	13,950 €	21



Aguja para dardo de cerbatana

Ref.	Medida	Salidas	PVP	IVA
13340/A25	0,9 x 25 mm	1	7,490 €	21
13340/A38	1,2 x 38 mm	1	5,860 €	21
13340/A382	1,3 x 38 mm	2	6,900 €	21
13340/A30	2 x 30 mm	1	10,950 €	21
13340/A40	2 x 40 mm	1	10,950 €	21
13340/A60	2 x 60 mm	1	10,950 €	21



13340/A25



13340/A38 + A382



13340/A30 + A40 + A60

Dardo para cerbatana

Ref.	Capac.	PVP	IVA
13340/D3	3 cc	11,900 €	21
13340/D5	5 cc	13,900 €	21
13340/D10	10 cc	53,900 €	21



Dardo Speedy para cerbatana

- Jeringas automáticas de un solo uso, compatibles con todas los proyectores de 13 mm.
- Capacidad: 3 ml.
- Alcance de 5 a 40 m.



Ref.	Aguja	Cant.	PVP	IVA
13340/20x2	20 x Ø 2 mm	4	139,950 €	21
13340/30x2	30 x Ø 2 mm	4	149,950 €	21

Cartuchos Dist-inject para rifle 13 mm

- Cápsulas con percutor que activan la inyección del producto en el momento del impacto.
- Se coloca en el pistón, dentro del cilindro de aluminio anodizado



Ref.	Nº	Alcance	Color	Cant.	PVP	IVA
13325/AM	2013	5 - 30 m	Amarillo	20	49,900 €	21
13325/C	2019	20 - 40 m	Marrón	20	49,900 €	21



Estabilizador emplumado Dist-inject para dardo aluminio de rifle 13 mm

- Estabiliza la jeringa y permite disparos precisos a gran distancia

Ref.	Nº	PVP	IVA
13325/E	3049	42,850 €	21



Detonadores Dist-inject para dardo de rifle 13 mm

- Cápsulas con percutor que activan la inyección del producto en el momento del impacto.
- Se coloca en el pistón, dentro del cilindro de aluminio anodizado

Ref.	Nº	Medida	Cant.	PVP	IVA
13325/D5	2006	1 - 5 ml	10	51,150 €	21
13325/D	2007	7 - 10 ml	10	50,350 €	21



Pistón Dist-inject para dardo aluminio de rifle 13 mm

- Pistón de goma para lubricar el cilindro de la jeringa de aluminio antes de su uso y recibir el detonador

Ref.	Nº	PVP	IVA
13325/P	3043	7,590 €	21



Cilindro aluminio Dist-inject para dardo de rifle 13 mm

- Cilindros de aluminio anodizado de alta calidad
- Permiten disparos potentes y con buenos resultados

Ref.	Nº	Capac.	PVP	IVA
13325/CI3	3023	3 ml	18,850 €	21
13325/CI5	3025	5 ml	19,950 €	21
13325/CI7	3027	7 ml	21,600 €	21
13325/CI10	3030	10 ml	23,950 €	21
13325/CI15	3035	15 ml	28,200 €	21



Aguja Dist-inject para dardo de rifle

- Los dos orificios permiten la inyección del producto en el momento del impacto.

Ref.	Nº	Medida	Modelo	PVP	IVA
13325/A28	NC2	28 x Ø 2,5 mm	Gancho	15,550 €	21
13325/A38	NC3	41 x Ø 2,5 mm	Gancho	15,950 €	21
13325/AC28	NM1	28 x Ø 2,5 mm	Collarín	16,550 €	21
13325/AC38	NM3	41 x Ø 2,5 mm	Collarín	16,950 €	21



Anilla nasal acero con cierre

Ref.	Ø Anilla	Calidad	PVP	IVA
4560	54 mm	B	7,690 €	21
4565	60 mm	B	8,090 €	21
4565/H	60 mm	Hauptner	22,950 €	21



Anilla nasal niquelada con cierre

Ref.	Ø Anilla	PVP	IVA
4510	52 mm	2,900 €	21
4520	60 mm	3,200 €	21



Anilla nasal niquelada

Ref.	Ø Anilla	PVP	IVA
4566	20 mm	0,390 €	21
4568	30 mm	0,490 €	21



Anilla nasal latón con cierre

Ref.	Ø Anilla	PVP	IVA
4535	52 mm	3,690 €	21
4545	60 mm	3,990 €	21
4550	65 mm	4,590 €	21
4555	70 mm	4,990 €	21



Anilla nasal latón con giro

Ref.	Ø Anilla	PVP	IVA
4563	60 mm	7,150 €	21



Tenaza para anillas nasales

Ref.	Ø Anilla	PVP	IVA
4630	20 - 30 mm	10,900 €	21
4635	40 mm	11,900 €	21



Tenaza para anillas nasales

Ref.	Ø Anilla	PVP	IVA
4610	52 - 54 mm	25,950 €	21



Tenaza para anillas nasales con giro

Ref.	Ø Anilla	PVP	IVA
4625	60 - 65 mm	105,950 €	21



Grapa triangular para cerdos

Ref.	Nº	Medida	Cant.	PVP	IVA
4580	3	30 mm	100	2,490 €	21
4585	4	35 mm	100	2,790 €	21
4590	5	39 mm	100	3,190 €	21
4595	6	42 mm	100	3,790 €	21



Grapa triangular para cerdos / vacas Hauptner

Ref.	Medida	Cant.	PVP	IVA
4593/H	33 mm	100	10,950 €	21



Grapa redonda para cerdos

Ref.	Nº	Medida	Cant.	PVP	IVA
4586	4	25,4 mm = 1"	144	3,890 €	21
4592	5	31,8 mm = 1 1/4"	144	4,225 €	21



Tenaza para grapas para cerdos

Ref.	Grapa	PVP	IVA
4640	Triangular	7,900 €	21
4655	Redonda	9,950 €	21



4640



4655

Nariguera con cierre Harms

Ref.	Long.	PVP	IVA
4340	19 cm	7,900 €	21



Nariguera de muelle con protector

Ref.	Long.	PVP	IVA
4331	11 cm	3,950 €	21
4330	17 cm	9,950 €	21



Nariguera para sujeción con lazo

Ref.	Long.	PVP	IVA
4310	20 cm	7,550 €	21



Nariguera doble mango

Ref.	Long.	PVP	IVA
4325	44 cm	14,790 €	21



Nariguera Eisenhut

Ref.	Long.	PVP	IVA
4320	44 cm	12,950 €	21



Pinza sujetacolas

Ref.	PVP	IVA
4770	5,450 €	21



Lazo morro de cerdos con freno

Ref.	Calidad	PVP	IVA
4740/A	A	11,900 €	21
4740	B	10,900 €	21



4740/A



4740

Lazo morro de cerdos

Ref.	Calidad	PVP	IVA
4750/A	A	10,900 €	21
4750	B	9,900 €	21



4750/A



4750

Lazo de sirga morro de cerdos

Ref.	PVP	IVA
4760	7,900 €	21



Lazo corto morro de cerdos

Ref.	PVP	IVA
4780	7,950 €	21



Bastón metálico

Ref.	Modelo	Long.	PVP	IVA
4885	Patatas	95 cm	13,900 €	21
4880	Patatas	130 cm	15,900 €	21
4890	Cuello y patas	125 cm	16,950 €	21
4858	Aves	115 cm	4,900 €	21
4730	Toros	150 cm	39,950 €	21



4880 - 4885



4890



4858



4730

Cabezal para bastón

Ref.	Material	PVP	IVA
4860	Aluminio	5,950 €	21
4865	Níquel	7,950 €	21



4865



4860

Trabón para patas con cierre

Ref.	Material	PVP	IVA
4830	Cuero	12,500 €	21



Trabón para patas reforzado regulable

Ref.	Material	PVP	IVA
4835	Nylon	13,900 €	21



Trabón para patas estándar

Ref.	Material	PVP	IVA
4840	Nylon	8,900 €	21



Cadena para patas con ganchos

Ref.	PVP	IVA
4850	9,950 €	21



Inmovilizador para ovino

Ref.	Talla	PVP	IVA
4875	Pequeño	16,950 €	21
4870	Grande	22,450 €	21



Traba correctora para lechones

Ref.	PVP	IVA
4895	0,950 €	21



Goma sujecion con ganchos

- Ø 8 mm

Ref.	Descripción	PVP	IVA
4986	2 x 60 cm + 2 x 80 cm	4,950 €	21
4987	2 x 80 cm + 2 x 100 cm	5,950 €	21



Cincha sujeción para transporte

- Polyester impregnado con PU

Ref.	Long.	Ancho	Peso máx.	PVP	IVA
4990	8 m	50 mm	4.000 Kg	15,950 €	21
4995	15 m	50 mm	4.000 Kg	22,950 €	21



Amarre giratorio

Ref.	Ø	PVP	IVA
4952/5	5 mm	2,650 €	21
4952/6	6 mm	2,950 €	21
4952/7	7 mm	3,550 €	21



Amarre con cadena

Ref.	Long.	Uso	PVP	IVA
4906	150 cm	Terneros	8,990 €	21
4903	170 cm	Vacas	10,990 €	21
4905	190 cm	Vacas	14,990 €	21



Amarre reforzado con cadena

Ref.	Long.	Uso	PVP	IVA
4907	180 cm	Vacas	14,950 €	21
4909	190 cm	Vacas	15,250 €	21



Cadena con tiradores y anilla

Ref.	Long.	Ø cadena	Ø cuello	Uso	PVP	IVA
4931	60 cm	3 mm	40 cm	Cabras	6,900 €	21
4933	60 cm	4 mm	80 cm	Terneros	7,900 €	21
4935	60 cm	5 mm	100 cm	Vacas	10,950 €	21
4937	65 cm	6 mm	110 cm	Vacas	12,950 €	21
4939	70 cm	7 mm	120 cm	Vacas	16,950 €	21



Collar tubular

Ref.	Long.	Ø	Uso	PVP	IVA
4915	55 cm	8 mm	Terneros	7,950 €	21
4917	78 cm	10 mm	Vacas	8,950 €	21
4919	85 cm	10 mm	Toros	9,950 €	21



Collar tubular con gancho

Ref.	Long.	Ø	PVP	IVA
4921	88 cm	10 mm	15,950 €	21



Collar eslabones planos

Ref.	Long.	Eslabones	PVP	IVA
4927	66 cm	Ø 50 mm x 8 mm	8,900 €	21
4923	90 cm	Ø 55 mm x 9 mm	9,900 €	



Collar eslabones planos con cinta

- Cinta nylon de 35 cm

Ref.	Long.	Eslabones	PVP	IVA
4929	78 cm	Ø 50 mm x 9 mm	13,900 €	21



Cadena de amarre

Ref.	Long.	Ø	PVP	IVA
4911	180 cm	10 mm	14,900 €	21
4913	190 cm	10 mm	15,900 €	21



Pasador de horquilla sencillo

Ref.	Long.	Ø	PVP	IVA
4981	40 mm	2 mm	0,079 €	21
4982	65 mm	3 mm	0,099 €	21
4983	75 mm	4 mm	0,139 €	21
4984	105 mm	5 mm	0,319 €	21
4985	115 mm	6 mm	0,399 €	21



Pasador de horquilla doble

Ref.	Long.	Ø	PVP	IVA
4991	75 mm	3 mm	0,139 €	21
4992	90 mm	4 mm	0,289 €	21
4993	110 mm	5 mm	0,439 €	21
4994	120 mm	6 mm	0,689 €	21



Mosquetón con anilla

Ref.	Long.	Anilla	PVP	IVA
4950/01	11 cm	Redonda	2,850 €	21
4940/01	10 cm	Cuadrada	2,850 €	21



4950/01



4940/01

Mosquetón

Ref.	Long.	Ø	PVP	IVA
4961	40 mm	4 mm	0,450 €	21
4962	50 mm	5 mm	0,490 €	21
4963	60 mm	6 mm	0,540 €	21
4964	70 mm	7 mm	0,690 €	21
4965	80 mm	8 mm	0,790 €	21
4966	90 mm	9 mm	0,890 €	21
4967	100 mm	10 mm	0,990 €	21
4968	120 mm	11 mm	1,290 €	21
4969	140 mm	12 mm	2,390 €	21



Mosquetón de rosca

Ref.	Long.	Ø	PVP	IVA
4946	50 mm	5 mm	0,450 €	21
4947	57 mm	6 mm	0,550 €	21
4948	65 mm	7 mm	0,890 €	21
4949	73 mm	8 mm	1,090 €	21
4996	80 mm	9 mm	1,290 €	21
4997	88 mm	10 mm	1,690 €	21
4998	102 mm	12 mm	2,190 €	21



Grillete curvo

Ref.	Long.	Ø	PVP	IVA
4951	39 mm	6 mm	0,450 €	21
4952	45 mm	8 mm	0,550 €	21
4953	53 mm	10 mm	0,650 €	21
4954	70 mm	12 mm	1,050 €	21



Grillete recto

Ref.	Long.	Ø	PVP	IVA
4971	35 mm	6 mm	0,590 €	21
4972	45 mm	8 mm	0,650 €	21
4973	55 mm	10 mm	0,690 €	21
4974	70 mm	12 mm	0,950 €	21
4975	80 mm	14 mm	1,950 €	21



Collar de lona con doble hebilla

Ref.	Medidas	Uso	PVP	IVA
2650	110 x 5 cm	Vacuno	5,980 €	21



Collar de lona con doble hebilla

Ref.	Medidas	Color	Uso	PVP	IVA
12275/BL	40 x 5 cm	Blanco	Caprino	3,790 €	21
12275/V	40 x 5 cm	Verde	Caprino	3,790 €	21
12276/BL	46 x 5 cm	Blanco	Caprino	3,950 €	21
12276/V	46 x 5 cm	Verde	Caprino	3,950 €	21



Collar de lona

Ref.	Medidas	Color	Uso	PVP	IVA
12270/BL	48 x 2,5 cm	Blanco	Ovino	2,450 €	21
12270/V	48 x 2,5 cm	Verde	Ovino	2,450 €	21
12270/AZ	48 x 2,5 cm	Azul	Ovino	2,450 €	21



Collar de lona

Ref.	Medidas	Color	Uso	PVP	IVA
12278/BL	40 x 4 cm	Blanco	Caprino	2,590 €	21
12278/V	40 x 4 cm	Verde	Caprino	2,590 €	21
12278/AZ	40 x 4 cm	Azul	Caprino	2,590 €	21



Collar de cuero

Ref.	Medidas	Uso	PVP	IVA
2651	50 x 4 cm	Ovino	9,950 €	21
2652	120 x 5 cm	Vacuno	22,500 €	21



2651



2652

Cencerro rectangular para perros

Ref.	Altura	Badajo	PVP	IVA
2615/H0	3,5 cm	Hierro	6,950 €	21
2615/H1	4,5 cm	Hierro	7,950 €	21
2625/P2	5 cm	Plástico	8,950 €	21
2615/H3	6 cm	Hierro	9,450 €	21
2625/P3	6 cm	Plástico	9,950 €	21



Cencerro Dumba para ovejas

Ref.	Altura	Badajo	PVP	IVA
2630/6	8,5 cm	Plástico	12,950 €	21
2630/4	9,5 cm	Plástico	13,950 €	21



Cencerro Kalaska para ovejas

Ref.	Altura	Badajo	PVP	IVA
2635/1	7 cm	Plástico	10,950 €	21
2635/3	7,5 cm	Plástico	12,550 €	21
2635/7	8 cm	Plástico	13,950 €	21



Cencerro Kalaska para vacas / yeguas

Ref.	Altura	Badajo	PVP	IVA
2635/10	13 cm	Plástico	21,950 €	21
2635/11	14 cm	Plástico	24,950 €	21
2635/12	16 cm	Plástico	29,950 €	21
2635/15	18 cm	Plástico	32,950 €	21



Cencerro redondo para vacas / yeguas

Ref.	Altura	Badajo	PVP	IVA
2640/9	16 cm	Plástico	27,950 €	21
2640/13	18,5 cm	Plástico	30,950 €	21
2640/17	23 cm	Plástico	45,950 €	21



Cabezada de nylon

Ref.	Uso	Cadena	PVP	IVA
5010	Terneros	No	9,950 €	21
5015	Vacas	No	11,950 €	21
5019	Vacas	Si	12,950 €	21
5021	Vacas	Si	14,950 €	21



5010 - 5015



5019



5021

Cabezada de nylon

Ref.	Uso	PVP	IVA
5018	Vacas	12,500 €	21



Cabezada de cuero con anilla

Ref.	Uso	PVP	IVA
5017	Toros	46,950 €	21



Cabezada de cuero

Ref.	Uso	PVP	IVA
4901	Toros	12,550 €	21



Bozal de plástico

Ref.	Uso	PVP	IVA
5645	Terneros	4,250 €	21



Collar con amarre giratorio

Ref.	Long.	Ancho	Uso	PVP	IVA
4925	80 cm	4 cm	Terneros	6,150 €	21



Collar con amarre giratorio

Ref.	Long.	Ancho	Uso	PVP	IVA
4955/CG	130 cm	4 cm	Vacas	8,950 €	21

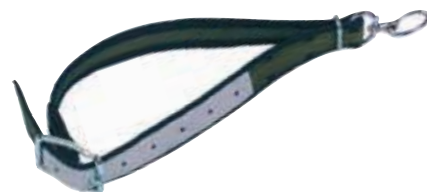

Collar de amarre

Ref.	Long.	Ancho	Uso	PVP	IVA
4957	100 cm	4 cm	Terneros	6,350 €	21
4955	130 cm	4 cm	Vacas	6,650 €	21



Collar de amarre con hebilla de doble aguja

Ref.	Long.	Ancho	Uso	PVP	IVA
4999	170 cm	7 cm	Toros	26,950 €	21



Collar con doble amarre de nylon

Ref.	Long.	Ancho	Uso	PVP	IVA
4940	130 cm	4 cm	Vacas	14,950 €	21



Collar de amarre con cadena

Ref.	Long.	Ancho	Cadena	Uso	PVP	IVA
4920	85 cm	4 cm	Simple 60 cm	Terneros	11,550 €	21
4950	130 cm	4 cm	Doble 65 + 65 cm	Vacas	17,950 €	21



Cabezada clásica de nylon para caballos

- Disponibles en rojo, azul y negro

Ref.	Talla	PVP	IVA
5050	0	7,950 €	21
5040	2	7,950 €	21
5030	3	7,950 €	21



Cabezada de nylon para caballos

- Disponibles en rojo, azul, negro y beige

Ref.	Talla	PVP	IVA
5007	0	4,950 €	21
5009	1	4,950 €	21
5011	2	4,950 €	21

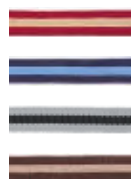

Cabezada reforzada de nylon para caballos

- Disponibles en rojo, azul y verde

Ref.	Talla	PVP	IVA
5012	1	19,350 €	21
5014	2	19,350 €	21
5013	3	19,350 €	21

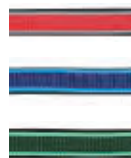

Cabezada Mustang de nylon con doble ajuste para caballos

- Disponibles en rojo, azul y negro

Ref.	Talla	PVP	IVA
5061	1	8,950 €	21
5062	2	8,950 €	21
5063	3	8,950 €	21

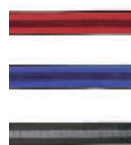

Cabezada reforzada de nylon para caballos

- Banderas disponibles: española, andaluza, catalana, extremeña y portuguesa

Ref.	Talla	PVP	IVA
5081	3	10,950 €	21



Cabezada de nylon para potros y ponys

- Disponibles en rojo, azul, verde y gris

Ref.	Talla	Color	PVP	IVA
5055	0	Rojo	11,950 €	21
5057	0	Azul	11,950 €	21
5056	0	Verde	11,950 €	21
5054	0	Gris	11,950 €	21



Cabezada de cuero para caballos

- Disponibles en marrón y negro

Ref.	Talla	PVP	IVA
5074	1	21,950 €	21
5075	2	21,950 €	21
5076	3	21,950 €	21



Cabezada inglesa de cuero para caballos

- Disponibles en marrón y negro
- Incluye riendas
- Bocado no incluido

Ref.	Talla	PVP	IVA
5044	2	21,950 €	21



Cabezada de cuerda para caballos

- Talla única, ajustable mediante nudos

Ref.	Color	PVP	IVA
5084	Negro	8,550 €	21



Protector de moscas para caballos

Ref.	Talla	Protección	PVP	IVA
3695	3	Orejas	5,950 €	21
3694	2	Ojos	4,900 €	21
3692	2	Orejas y ojos	14,950 €	21
3665	2	Orejas, ojos y nariz	14,950 €	21



0 Pony Shetland 1 Pony 2 Pura sangre 3 Sangre tibia 4 Sangre tibia grande 5 Sangre fría

Cuerda de perlón para cabezadas

- Gancho antipánico

Ref.	Long.	Color	PVP	IVA
5087	200 cm	Rojo	5,950 €	21
5080	200 cm	Azul	5,950 €	21
5090	200 cm	Negro	5,950 €	21



Cadena de sujeción

- Gancho antipánico y mosquetón

Ref.	Long.	PVP	IVA
5094	70 cm	10,350 €	21
5096	140 cm	12,950 €	21



Cadena de sujeción con asa de nylon

Ref.	Long.	Color	PVP	IVA
5092/R	190 cm	Rojo	10,250 €	21
5092/AZ	190 cm	Azul	10,250 €	21
5092/V	190 cm	Verde	10,250 €	21
5092/G	190 cm	Gris	10,250 €	21
5093	250 cm	Negra	8,900 €	21



Riendas

Ref.	Talla	Color	Cant.	PVP	IVA
5043	3	Negro	2	14,450 €	21



Fusta

Ref.	Long.	PVP	IVA
5065	65 cm	5,590 €	21
5066	65 cm	9,990 €	21

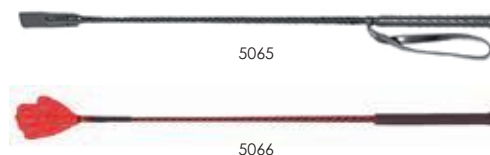

Bozal de nylon

Ref.	Talla	PVP	IVA
3632	1	19,900 €	21
3633	2	20,900 €	21
3634	3	21,900 €	21



Bocado

Ref.	Long.	Modelo	PVP	IVA
5029	13,5 cm	Sencillo	11,900 €	21
5026	13,5 cm	Doble	14,900 €	21



Protector de bocado

Ref.	Ø	Color	Cant.	PVP	IVA
5045/7	7 cm	Negro	2	2,650 €	21
5045/9	9 cm	Negro	2	2,750 €	21



Camisa de nylon antimoscas

Ref.	Largo sup.	Largo inf.	Color	PVP	IVA
3663	125 cm	175 cm	Azul	29,900 €	21
3666	125 cm	175 cm	Gris	29,900 €	21
3664	145 cm	195 cm	Azul	29,900 €	21
3667	145 cm	195 cm	Gris	29,900 €	21



Camisa de algodón antimoscas

Ref.	Largo sup.	Largo inf.	Color	PVP	IVA
3659	135 cm	185 cm	Azul	15,900 €	21
3660	135 cm	185 cm	Gris	15,900 €	21
3661	145 cm	195 cm	Gris	15,900 €	21



Camisa para transporte antitranspirable

Ref.	Largo sup.	Largo inf.	Color	PVP	IVA
3678	105 cm	155 cm	Negro / Blanco	25,900 €	21



Camisa impermeable

Ref.	Largo sup.	Largo inf.	Color	PVP	IVA
3688	105 cm	155 cm	Azul	58,900 €	21
3685	105 cm	155 cm	Negro	58,900 €	21
3686	135 cm	185 cm	Negro	58,900 €	21
3690	145 cm	195 cm	Azul	58,900 €	21
3687	145 cm	195 cm	Negro	58,900 €	21



Cincha regulable para mantas

Ref.	PVP	IVA
3662	6,900 €	21



Venda para trabajo

- Pack de 4 uds

Ref.	Medidas	Color	Modelo	PVP	IVA
3652	300 x 12 cm	Negro	Sencillo	10,900 €	21
3653	300 x 12 cm	Verde	Sencillo	10,900 €	21
3655	300 x 12 cm	Negro	Reforzado	13,900 €	21
3657	300 x 12 cm	Blanco	Reforzado	13,900 €	21



Silla de montar

Ref.	Talla	Modelo	PVP	IVA
5037	17,5"	Completa	175,900 €	21
5038	16"	Sin accesorios	249,750 €	21



5037



5038

Protector para silla de montar

Ref.	Color	PVP	IVA
5031	Azul	23,900 €	21
5033	Negro	23,900 €	21
5035	Rojo	10,900 €	21



5031



5033



5035

Funda de algodón para silla de montar

Ref.	Modelo	PVP	IVA
5039	Silla modelo inglés	8,950 €	21



Soporte para silla de montar

Ref.	Long.	Color	Modelo	PVP	IVA
5071	38 cm	Rojo	Sencillo	11,950 €	21
5073/R	44 cm	Rojo	Soporte para bridas	13,550 €	21
5073/N	44 cm	Negro	Soporte para bridas	13,550 €	21
5072/R	44 cm	Rojo	Silla modelo inglés	9,900 €	21
5072/N	44 cm	Negro	Silla modelo inglés	9,900 €	21



5071



5073



5072

Cepillo de plástico

- Pasador de mano ajustable

Ref.	Medidas	PVP	IVA
10660	17,5 x 8,5 cm	1,350 €	21



Rasqueta metálica ovalada

- 3 hileras dentadas y onduladas

Ref.	Medidas	PVP	IVA
10615	17 x 10 cm	4,450 €	21



Bruza de latón

- 9 filas de cerdas: 7 de alambre de latón ondulado y 2 de nylon
- Lomo de mandera y pasador de mano de cuero

Ref.	Medidas	PVP	IVA
10610	21,5 x 10 cm	8,950 €	21



Bruza de nylon

- Lomo de madera y pasador de mano

Ref.	Medidas	PVP	IVA
10620	24 x 10 cm	4,650 €	21



Almohaza recta

- Doble asa de PVC

Ref.	PVP	IVA
10680	4,950 €	21



Almohaza Oster

- Perfil blando

Ref.	PVP	IVA
10675	6,900 €	21



Almohaza

Ref.	PVP	IVA
10670	4,150 €	21



Rasqueta vacuno 3 filas

- Mango de plástico
- Dientes gruesos
- 2 placas de limpieza

Ref.	Medidas	PVP	IVA
10630	10 x 14,5 cm	3,950 €	21



Rasqueta equino 8 filas

- Mango de plástico
- Dientes finos
- 2 placas de limpieza

Ref.	Medidas	PVP	IVA
10640	10 x 14,5 cm	4,150 €	21



Rasqueta equino 8 filas con peine para crin

- Mango de madera
- Dientes finos

Ref.	Medidas	PVP	IVA
10652	12 x 12,5 cm	6,850 €	21



Rasqueta 8 filas

- Mango de madera

Ref.	Medidas	PVP	IVA
10654	11 x 12,5 cm	6,500 €	21



Rasqueta equino circular

- Utilizable por ambos lados
- Dientes finos

Ref.	Ø	PVP	IVA
10656	10,5 cm	4,350 €	21



Rasqueta semicircular 2 filas

Ref.	Medidas	PVP	IVA
10650	5,5 x 12,5 cm	3,150 €	21



Rasqueta 8 filas

- Pqñador de metal

Ref.	Medidas	PVP	IVA
10645	11 x 12 cm	4,590 €	21



Spray anti canibalismo

- Para conseguir tranquilidad y buen ambiente en el establo
- Modifica de forma duradera el olor del entorno de los cerdos



Ref.	Capac.	PVP	IVA
5440	400 ml	7,150 €	21

Bola para morder porcino

Ref.	Ø	Modelo	Uso	PVP	IVA
5457/55G	55 mm	Galvanizado	Lechones	6,980 €	21
5457/55A	55 mm	Acero inox	Lechones	8,500 €	21
5457/75G	75 mm	Galvanizado	Engorde	7,980 €	21
5457/75A	75 mm	Acero inox	Engorde	9,250 €	21
5466	Cadena de recambio 75 cm Ø 4 mm			2,150 €	21



Pelota anti stress porcino

Ref.	Ø	Uso	PVP	IVA
5456/30	30 cm	Lechones	15,890 €	21



Disco para morder porcino

Ref.	Ø	Cadena	Uso	PVP	IVA
5458	180 mm	75 cm	Lechones	8,950 €	21
5466	Cadena de recambio 75 cm Ø 4 mm			2,150 €	21



Mordedor porcino

- Suministrado con material para atornillar, sin cadena

Ref.	Descripción	PVP	IVA
5463	Cilindro	10,400 €	21
5466	Cadena de recambio 75 cm Ø 4 mm	2,150 €	21



Cuerda de sisal para morder

Ref.	Ø	Long.	PVP	IVA
5467	12 mm	320 cm	2,350 €	21



Incubadora manual Mini

- 230 V
- Termostato electrónico
- Indicador de temperatura visible desde el exterior

Ref.	PVP	IVA
10780	90,950 €	21

Ave	Nº huevos
-----	-----------

Pato	11
Gallina	16
Faisán	18
Perdiz	26



Incubadora automática Maxi

- 230 V
- Fácil limpieza, incorpora una bandeja de humedad
- Termostato electrónico
- Indicador de temperatura visible desde el exterior
- Volteador gira los huevos 180° cada hora

Ref.	PVP	IVA
10782	260,950 €	21

Ave	Nº huevos
-----	-----------

Pato	20
Gallina	24
Faisán	30
Perdiz	42



Ovoscopio

- Bombilla no incluida

Ref.	Descripción	PVP	IVA
10785	Ovoscopio	21,950 €	21
10785/01	Bombilla 60W	7,250 €	21



Huevos postizos

- Para gallinas
- Útil para mostrar el ponedero y estimular la puesta

Ref.	Material	Cant.	PVP	IVA
73002	Madera	2	3,690 €	21
73004	Arcilla	2	2,690 €	21



Pinza para sacrificio aves de corral

Ref.	PVP	IVA
13165	14,900 €	21



Comedero para gallinas

- Chapa galvanizada
- Muy resistentes

Ref.	Medidas	Ave	PVP	IVA
71202	50 x 7 cm	Pollitos	7,460 €	21
71301	50 x 10 cm	Gallinas	9,270 €	21
71302	75 x 10 cm	Gallinas	12,680 €	21
71303	100 x 10 cm	Gallinas	15,880 €	21



Comedero para gallinas

- Plástico

Ref.	Medidas	Ave	PVP	IVA
71330	50 x 7 cm	Pollitos	5,250 €	21
71331	50 x 12 cm	Gallinas	7,250 €	21
71332	75 x 12 cm	Gallinas	8,850 €	21

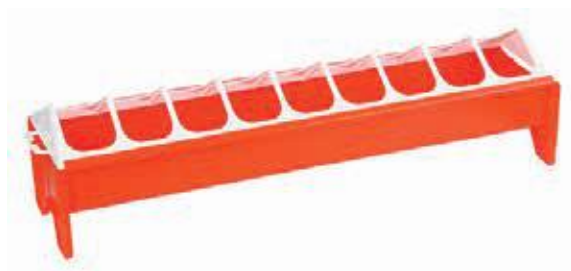

Comedero para gallinas Stückerjürgen

- Plástico de alta calidad

Ref.	Medidas	Ave	PVP	IVA
71310	50 x 7 cm	Pollitos	11,950 €	21
71312	50 x 10 cm	Pollitos	15,850 €	21
71313	75 x 10 cm	Pollitos	19,900 €	21
71314	75 x 20 cm	Gallinas	28,900 €	21
71315	100 x 20 cm	Gallinas	32,900 €	21



Pelador para aves

- 230 V
- Tambor con 24 dedos
- Rendimiento de desplumado: aprox. 80 gallinas por hora
- Altura de trabajo: 79 cm

Ref.	PVP	IVA
13160	589,950 €	21



Bebedero de plástico

- Para pollitos y gallinas
- Adecuado para todo tipo de líquidos

Ref.	Capac.	PVP	IVA
70202	1.5 L	2,880 €	21
70203	3.0 L	3,300 €	21
70205	5.0 L	3,975 €	21
70210	10.0 L	9,350 €	21



Bebedero de cubo para aves

- Asa de transporte
- Con suministro de agua automático

Ref.	Capac.	PVP	IVA
71117	18.0 L	23,780 €	21



Bebedero de plástico Stükerjürgen

- Para pollitos y gallinas criados en el suelo
- Se puede colgar para reducir la suciedad

Ref.	Capac.	PVP	IVA
70259	1.5 L	5,900 €	21
70260	3.5 L	8,850 €	21
70261	5.5 L	12,950 €	21



Bebedero de plástico de doble cilindro Stükerjürgen

- Para aves criadas en el suelo
- Asa de transporte, también se puede colgar

Ref.	Capac.	PVP	IVA
70216	6.0 L	21,800 €	21
70215	12.0 L	27,600 €	21



Bebedero para aves Eco

- Asa para transporte, apto para colgar

Ref.	Capac.	Medidas	PVP	IVA
74305	8.0 L	Ø 31,5 x 30,5 cm	8,250 €	21
74307	10.0 L	Ø 34,5 x 34 cm	10,900 €	21



Bebedero y comedero para palomas

- Plástico

Ref.	Capac.	Descripción	PVP	IVA
70253	5.0 L	Bebedero	11,750 €	21
70252	5.0 L	Comedero	11,750 €	21



70253



70252

Comedero automático

- Plástico

Ref.	Capac.	PVP	IVA
71126	5.25 L	10,950 €	21
71118	10.5 L	11,950 €	21
71116	20.0 L	17,950 €	21



Tolva metálica

- Chapa galvanizada

Ref.	Capac.	Medidas	PVP	IVA
74310	10 kg	Ø 33 x 41 cm	22,450 €	21
74315	20 kg	Ø 40 x 46 cm	30,450 €	21



Anillas de plástico para patas en espiral

- Para gallinas, pavos, faisanes, etc.
- Triple giro
- Muy resistentes
- * Surtidos = rojo, verde, azul y amarillo (25 uds de cada)

Ref.	Ø	Color	Cant.	PVP	IVA
72315	12 mm	Surtido *	100	12,950 €	21
72316	16 mm	Surtido *	100	14,300 €	21
72317	20 mm	Surtido *	100	16,950 €	21
72101	16 mm	Rojo	20	3,800 €	21
72102	16 mm	Verde	20	3,800 €	21
72103	16 mm	Azul	20	3,800 €	21
72106	16 mm	Amarillo	20	3,800 €	21



Anillas de plástico para patas

- Para gallinas, pavos, faisanes, etc.
- * Surtidos = rojo, verde, azul, amarillo y blanco (20 uds de cada)

Ref.	Ø	Color	Cant.	PVP	IVA
72350	8 mm	Surtido *	100	18,450 €	21
72351	12 mm	Surtido *	100	21,500 €	21
72352	16 mm	Surtido *	100	21,950 €	21



Anteojos para gallinas

- Plástico

Ref.	Medidas	Cant.	PVP	IVA
12150	4 x 2 cm	100	11,990 €	21
12160	5 x 3 cm	100	11,990 €	21



Lámpara para bombilla de infrarrojos

- Pantalla de aluminio
- Ranuras de aireación para una mejor circulación del aire
- Cadena de sujeción (capacidad 20 kg máx.)

Ref.	Cadena	Ø	Ranuras	PVP	IVA
10710	2,5 m	21 cm	6	13,550 €	21
10710/5	5 m	21 cm	6	16,750 €	21
10775	5 m	35 cm	8	25,950 €	21



10710 - 10710/5



10775

Bombillas de infrarrojos de bajo consumo Philips

- Diseño robusto de vidrio prensado
- PAR 38
- Ahorro hasta un 30 % en gasto energético (en comparación con las bombillas de infrarrojos convencionales)
- Resistente a salpicaduras
- Uso universal, p. ej. aves, lechones, tratamiento veterinario, procesos de secado de alimentos y piensos agrícolas



Ref.	Color	Potencia	PVP	IVA
10704	Blanca	100 W	8,950 €	21
10703	Roja	100 W	8,950 €	21
10701	Blanca	175 W	8,690 €	21
10702	Roja	175 W	8,690 €	21

Bombilla de infrarrojos de bajo consumo Ako

- Económicas
- PAR 38
- Modelo robusto
- Excelente transmisión del calor
- Resistente a salpicaduras



Ref.	Color	Potencia	PVP	IVA
10701/B	Blanca	175 W	7,050 €	21
10702/B	Roja	175 W	6,250 €	21

Bombilla de infrarrojos de vidrio templado Philips

- 240 V
- El vidrio templado protege de las salpicaduras
- Doble reflector para irradiar más calor y ampliar el campo de radiación
- 600 W/m² a 60 cm de altura en lugar de los 400 W/m² de las lámparas Philips convencionales



Ref.	Color	Potencia	PVP	IVA
10722	Blanca	150 W	6,950 €	21
10720	Roja	150 W	6,950 €	21
10726	Blanca	250 W	7,350 €	21
10725	Roja	250 W	7,350 €	21

Pistola de sacrificio

Ref.	PVP	IVA
10730	149,950 €	21



Cartucho pistola de sacrificio

Caja de 50 uds

Ref.	Color	Uso	PVP	IVA
10740	Verde	Cerdo - Ternero	19,950 €	21
10745	Amarillo	Caballo - Vaca	19,950 €	21
10750	Azul	Toro - Bueyes	19,950 €	21
10755	Rojo	Toro gran tamaño	19,950 €	21



Cañón espantapájaros

Ref.	PVP	IVA
10835	279,950 €	21



Neutralizador de olores

- Perfecto para eliminar los olores más difíciles en todo tipo de estancias
- 3 aromas: Apple = neutro / Passion = dulce / Tropical = fresco

Ref.	Modelo	Capacidad	Alcance *	PVP	IVA
87072	Cera	170 gr	8 m ²	13,460 €	21
87074	Gel	500 ml	8 m ²	11,200 €	21
87075	Gel	1 L	15 m ²	20,400 €	21
87076	Gel	4 L	60 m ²	61,460 €	21
87077	Difusor gel	500cc / 1L / 4L	hasta 160 m ²	50,630 €	21

* Alcance aproximado



Neutralizador de olores Penetrator

- Específico para superficies con graves problemas de olor
- Penetra en todos los materiales

Ref.	Tipo	Capac.	PVP	IVA
87078/500	Spray	500 ml	14,800 €	21
87078/1000	Recambio	1 L	15,340 €	21
87078/4000	Recambio	4 L	47,800 €	21



Bandeja para desinfección de calzado

- Base de espuma

Ref.	Medidas	PVP	IVA
4218	57 x 37 x 7 cm	30,950 €	21



Lona para desinfección de calzado

- El material permeable de la parte superior permite la entrada de líquido al núcleo
- El material impermeable de la base y los laterales evita la pérdida de líquido

Ref.	Medidas	Capac.	PVP	IVA
4214	85 x 60 x 3 cm	8 L	51,950 €	21



Bandeja para desinfección de ganado

- Polietileno
- Permite agruparlas

Ref.	Medidas	Capac.	PVP	IVA
4217	203 x 80 x 18,5 cm	200 L	259,890 €	21



Bandeja para desinfección de ganado Suevia

- Poliuretano
- Diseño especial en forma de colmena para una mejor desinfección

Ref.	Medidas	Capac.	PVP	IVA
4216	200 x 90 x 15 cm	200 L	289,950 €	21

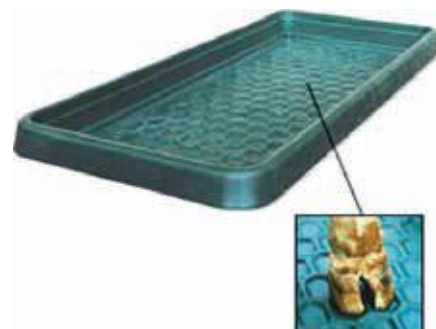

Lona para desinfección de ganado

Ref.	Medidas	PVP	IVA
4210	180 x 90 x 4 cm	135,950 €	21



Limpiador de cepillos para desinfección de calzado

- 3 cepillos

Ref.	Medidas	PVP	IVA
10475	30 x 28 x 14 cm	28,950 €	21



Limpiador de cepillos para desinfección de calzado

- 5 cepillos
- Llave de 1/2" para líquido desinfectante

Ref.	PVP	IVA
10480	179,950 €	21



Cepillo para higiene con depósito y muelle

- 2 cepillos
- Capacidad depósito: 20 L
- Ideal para evitar parásitos y mantener la piel limpia

Ref.	PVP	IVA
10410	248,950 €	21



Cepillo para higiene con muelle

- 2 cepillos
- Muelle y estructura reforzada

Ref.	PVP	IVA
10420	104,950 €	21



Cepillo para higiene eléctrico

- 230V 50Hz
- 46 r.p.m.

Ref.	Medidas	Peso	PVP	IVA
10470	120 x 50 x 110 cm	105 Kg	1.999,900 €	21



Soporte universal para cepillos

Ref.	Ø	PVP	IVA
10601	28 mm	2,350 €	21



Cepillo de limpieza

- Cuerpo de madera y cerdas de elástano
- Mango no incluido

Ref.	Medidas	Mango	PVP	IVA
10531	35 x 7 cm	10570	4,850 €	21
10533	42 x 7 cm	10570	5,150 €	21



Cepillo de limpieza con soporte

- Cuerpo de madera y cerdas de elástano
- Mango no incluido

Ref.	Medidas	Mango	PVP	IVA
10535	40 x 5,5 cm	10570	5,950 €	21
10536	50 x 5,5 cm	10570	7,300 €	21
10537	60 x 5,5 cm	10570	7,950 €	21
10542	80 x 5,5 cm	10570	15,950 €	21



Recogedor metálico y cepillo de coco

Ref.	Descripción	Medidas	PVP	IVA
10452	Recogedor	44 x 21 cm	3,550 €	21
10456	Cepillo	31 x 9 cm	2,750 €	21



10452



10456

Recogedor con cepillo

- PVC

Ref.	Medidas	PVP	IVA
10454	33 x 21 cm	3,100 €	21



Rasqueta

- PVC
- Mango no incluido

Ref.	Medidas	Mango	PVP	IVA
10493	35 x 11 cm	10570	3,890 €	21



Recogedor curvo

- Zincado con goma
- Mango no incluido

Ref.	Medidas	Mangos	PVP	IVA
10545	55 x 15 cm	10560 / 10576	16,950 €	21
10540	75 x 15 cm	10560 / 10576	20,950 €	21



Recogedor curvo reforzado

- Zincado con goma
- Mango no incluido

Ref.	Medidas	Mangos	PVP	IVA
10543	55 x 15 cm	10560 / 10576	17,950 €	21
10547	71 x 15 cm	10560 / 10576	21,950 €	21



Recogedor recto

- Acero con goma
- Mango no incluido

Ref.	Medidas	Mangos	PVP	IVA
10550	40 x 13 cm	10560 / 10576	11,950 €	21
10555	55 x 13 cm	10560 / 10576	12,950 €	21



Pala aluminio

- Mango no incluido
- Canto reforzado

Ref.	Medidas	Mangos	PVP	IVA
10513	27 x 37 cm	10580, 10585	11,900 €	21
10514	32 x 35 cm	10580, 10585	11,900 €	21
10515	36 x 40 cm	10580, 10585	11,900 €	21



10513

10514

10515

Pala plástico

- Mango no incluido
- Canto reforzado

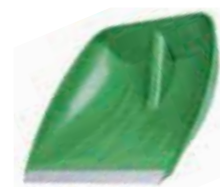

Ref.	Medidas	Mango	PVP	IVA
10530	42 x 40 cm	10532	10,500 €	21

Horca

- Mango no incluido

Ref.	Dientes	Medidas	Mangos	PVP	IVA
10521	3	26 x 20 cm	10580, 10585	13,900 €	21
10523	4	31 x 23 cm	10580, 10585	14,900 €	21
10525	5	31 x 24 cm	10580, 10585	18,900 €	21
10527	6	35 x 29 cm	10580, 10585	26,900 €	21



10521



10523



10525



10527

Horca curva

- Mango no incluido

Ref.	Dientes	Medidas	Mangos	PVP	IVA
10490	3	21 x 17 cm	10580, 10585	16,900 €	21
10492	4	21 x 20 cm	10580, 10585	17,900 €	21



10490



10492

Mango de metal

Ref.	Medidas	Material	PVP	IVA
10570	130 cm x Ø 24 mm	Madera	1,490 €	21
10575	150 cm x Ø 28 mm	Madera	3,350 €	21
10576	165 cm x Ø 30 mm	Madera	5,950 €	21
10560	150 cm x Ø 32 mm	Hierro	8,900 €	21
10580	120 cm x Ø 36 mm	Madera	3,950 €	21
10585	135 cm x Ø 36 mm	Madera *	6,950 €	21
10529/M	135 cm x Ø 36 mm	Madera **	10,950 €	21
10532	134 cm x Ø 39 mm	Aluminio ***	26,950 €	21

* curvo

** curvo con soporte de metal

*** curvo ovalado 28 x 35 mm, con mango antideslizante



10570

10575

10576

10560

10580

10585

10529/M

10532

Cepillo de limpieza

- Cuerpo y cerdas de resina de polietileno alta densidad
- Mango incluido

Ref.	Medidas	Mango	PVP	IVA
10440	35 x 8,5 cm	130 cm x Ø 24 mm *	14,950 €	21
10442	40 x 11 cm	140 cm x Ø 28 mm	17,950 €	21
10444	60 x 13 cm	140 cm x Ø 28 mm	22,950 €	21

* punta roscada



Escoba

- Mango incluido

Ref.	Medidas	Mango	Material	PVP	IVA
10450	31 x 17 cm	135 cm x Ø 24 mm	Poliéster	6,950 €	21
10462	46 x 18 cm	140 cm x Ø 24 mm	Mijo	5,950 €	21



10450

10462

Recogedor

- Aluminio con goma
- Mango incluido

Ref.	Medidas	Mango	PVP	IVA
10446	70 x 5 cm	150 cm	25,950 €	21



Pala arrimadora

- ABS
- Mango incluido

Ref.	Medidas	Mango	PVP	IVA
10430	66 x 21,5 cm	120 cm x Ø 32 mm	31,950 €	21
10432	65 x 28,5 cm	125 cm x Ø 32 mm	31,950 €	21



10430

10432

Pala

- Mango incluido

Ref.	Medidas	Mango	Material	Canto	PVP	IVA
10511	36 x 40 cm	135 cm x Ø 36 mm	Aluminio	Reforzado	15,950 €	21
10516	27 x 25 cm	120 cm x Ø 39 mm	Metal	Estándar	10,650 €	21
10517	30 x 27 cm	125 cm x Ø 39 mm	Metal	Estándar	10,950 €	21
10518	36 x 47 cm	120 cm x Ø 36 mm	Plástico	Estándar	29,950 €	21
10512	40 x 42 cm	120 cm x Ø 32 mm	Plástico	Reforzado	9,950 €	21
10434	36 x 48 cm	120 cm x Ø 32 mm	Plástico	Estándar	39,950 €	21



10511



10516



10517



10518



10512



10434

Horca

- Mango incluido

Ref.	Dientes	Medidas	Mango	PVP	IVA
10529/3	3	30 x 30 cm	135 cm x Ø 32 mm	23,950 €	21
10529	4	31 x 23 cm	135 cm x Ø 32 mm	23,950 €	21



10529/3



10529

Rastrillo

- Mango incluido

Ref.	Ancho	Mango	PVP	IVA
10439	43 cm	157 cm x Ø 32 mm	23,950 €	21
10436	60 cm	172 cm x Ø 32 mm	17,900 €	21
10438	80 cm	185 cm x Ø 32 mm	18,900 €	21



10439



10436



10438

Imán esofágico Bovi-mini

Ref.	Medidas	Uso	PVP	IVA
5520	100 x 25 mm	Terneros	2,950 €	21



Imán esofágico Bovi-vet

Ref.	Medidas	Uso	PVP	IVA
5510	105 x 35 mm	Vacas	1,590 €	21



Imán esofágico blanco Super II

Ref.	Medidas	Uso	PVP	IVA
5530	105 x 35 mm	Vacas	10,700 €	21



Aplicador de imanes esofágicos

Ref.	Imán	PVP	IVA
5575	Bovi-vet	25,950 €	21
5576	Bovi-mini	27,950 €	21



5575



5576

Sonda metálica de imanes esofágicos

Ref.	Sonda	Calidad	PVP	IVA
5540	Rígida	A	29,900 €	21
5550	Rígida	B	15,950 €	21
5560	Flexible	B	63,950 €	21



5540 - 5550



5560

Bomba C.P.S.

Ref.	Modelo	Sonda	PVP	IVA
5555	300	90 cm	509,950 €	21
5556	500	150 cm	569,950 €	21



Bomba estomacal Equivet

Ref.	PVP	IVA
5585	109,950 €	21



Detector de metales Hauptner

Ref.	PVP	IVA
5580	999,950 €	21



Trocar con cánula

Ref.	Mango	Medidas	PVP	IVA
5610	Madera	80 x 5 mm	5,900 €	21
5620	Madera	130 x 10 mm	6,900 €	21
5625	Madera	220 x 9 mm	7,900 €	21
5630	Metálico	90 x 5 mm	5,900 €	21
5635	Metálico	120 x 7 mm	6,900 €	21
5640	Metálico	150 x 10 mm	7,900 €	21



Trocar universal metálico

Ref.	PVP	IVA
5650	11,600 €	21



Trocar de plástico Kruise

Ref.	PVP	IVA
5663	12,950 €	21



Trocar de plástico Buff

Ref.	PVP	IVA
5660	7,950 €	21



Trocar Grymer Sterner

Ref.	PVP	IVA
7475	129,950 €	21



Lazo de sutura Grymer Sterner

Ref.	Material	Cant.	PVP	IVA
7465	Plástico	2	16,950 €	21
7465/M	Metal	2	11,950 €	21



7465



7465/M

Dispositivo de plástico para cuajar

Ref.	Medidas 1	Ø 2	Cant.	PVP	IVA
7485	93 x 23 mm	40 mm	6 (3+3)	39,950 €	21



Sonda esofágica

Ref.	Long.	Ø	Uso	PVP	IVA
5690	135 cm	14 mm	Terneros / ovino	33,950 €	21
5695	160 cm	18 mm	Vacas	36,950 €	21



Sonda esofágica Dr. Pick

Ref.	Long.	Ø	Uso	PVP	IVA
5692	200 cm	13 x 19 mm	Equino	332,950 €	21



Sonda gástrica

Ref.	Long.	Ø	Medida	PVP	IVA
5657	780 mm	8,7 mm	CH26	5,890 €	21
5656	780 mm	10 mm	CH30	6,250 €	21



Sonda gástrica Equivet

Ref.	Long.	Ø	PVP	IVA
5670	2.100 mm	9 mm	53,950 €	21
5675	2.700 mm	13 mm	55,950 €	21
5680	2.700 mm	16 mm	63,950 €	21
5685	3.000 mm	19 mm	64,950 €	21



Cadena para partos

Ref.	Modelo	PVP	IVA
5760	Sin asas	14,950 €	21
5750	Con asas	19,950 €	21



5760



5750

Cuerda para partos

Ref.	Long.	Lazos	Cant.	PVP	IVA
5740	85 cm	1	2	5,150 €	21
5745	190 cm	1	2	7,650 €	21
5730	200 cm	2	1	4,950 €	21
5735	300 cm	2	1	5,950 €	21



5740 - 5745



5730 - 5735

Empuñadura de nylon para partos

Ref.	PVP	IVA
5765	5,950 €	21



Pasador Sand

Ref.	Long.	Tornillo	PVP	IVA
5770/C	20 cm	Si	10,900 €	21
5770/S	20 cm	No	9,900 €	21



Avisador de partos Moocall

- Se coloca en la cola de la vaca
- Envía SMS + e-mail una hora antes del parto
- Aviso en caso de batería baja o caída del aparato



Ref.

5780

Extractor de partos modelo T

Ref.	Long.	PVP	IVA
5710	180 cm	158,900 €	21



Extractor de partos modelo Vink

Ref.	Long.	PVP	IVA
5820	180 cm	379,950 €	21



Extractor de partos modelo HK

Ref.	Long.	Posadera	PVP	IVA
5825	180 cm	Modelo "T" 58 cm	235,950 €	21
5828	180 cm	Basculante 57 cm	379,950 €	21



5828



5825



Reanimador de terneros

Ref.	PVP	IVA
5830	119,950 €	21



Embriótomo completo con funda

Ref.	PVP	IVA
6010	79,900 €	21



Forceps

Ref.	Long.	Modelo	Uso	PVP	IVA
6065	60 cm	Pahlson	Lechones	12,950 €	21
6055	45 cm	Witt cal. A	Lechones	89,950 €	21
6050	53 cm	Witt cal. B	Lechones	24,900 €	21



Gancho ocular Harms

Ref.	Modelo	Calidad	PVP	IVA
6090	Agudo	A	18,950 €	21
6091	Agudo	B	4,950 €	21
6095	Romo	A	18,950 €	21
6096	Romo	B	4,950 €	21



Gancho articulado Krey

Ref.	Calidad	PVP	IVA
6020	A	69,950 €	21
6025	B	9,900 €	21



Gancho Moses

Ref.	Medidas	Modelo	Uso	PVP	IVA
6030	440 x 4 mm	Agudo	Lechones	9,950 €	21
6035	440 x 4 mm	Romo	Lechones	9,950 €	21
6040	800 x 6 mm	-	Terneros	19,950 €	21



Instrumental Weingart

Ref.	Modelo	Medidas	Calidad	PVP	IVA
6080	Gancho	8 cm	A	18,950 €	21
6081	Gancho	8 cm	B	7,600 €	21
6060	Pinza	24 cm	A	99,950 €	21
6061	Pinza	24 cm	B	23,900 €	21
6070	Aro	27 x 18 cm	A	49,950 €	21
6071	Aro	27 x 18 cm	B	16,600 €	21



Cuchilla para cesárea

Ref.	PVP	IVA
6005	7,900 €	21



Escalpelo Linde

Ref.	PVP	IVA
6023	18,950 €	21



Prolapso de nylon para vacuno

Ref.	PVP	IVA
6110	49,950 €	21



Prolapso de cuero para vacuno

Ref.	PVP	IVA
6115	53,950 €	21



Prolapso de plástico para ovino / caprino

Ref.	Descripción	PVP	IVA
6120	Prolapso	0,990 €	21
6125	Arnés de nylon	16,950 €	21



Imperdible para prolapso

Ref.	Long.	Cant.	PVP	IVA
6135	8 cm	5	3,950 €	21
6130	10 cm	5	4,650 €	21
6160	13 cm	5	4,950 €	21



Imperdible para prolapso Genia

Ref.	Long.	Cant.	PVP	IVA
6135/G	6 cm	10	15,950 €	21
6130/G	8 cm	10	22,950 €	21
6160/G	11 cm	10	24,950 €	21



Clamp desechable para cordón umbilical

Ref.	Long.	PVP	IVA
6180	6,5 cm	0,440 €	21



Spray adopción corderos

Ref.	Capac.	PVP	IVA
6186	200 cc	10,950 €	21



Aguja para agrafe Hauptner

Ref.	PVP	IVA
6170/H	42,950 €	21



Ágrafe

Ref.	Long.	Férula	Prolapso	PVP	IVA
6140/P	65 mm	Plástico x2	Plástico x3	6,490 €	21
6145/P	75 mm	Plástico x2	Plástico x3	6,890 €	21
6140/M	60 mm	Plástico x2	Madera x3	8,490 €	21
6145/M	70 mm	Plástico x2	Madera x3	8,890 €	21
6145/H *	75 mm	Metal x2	Madera x3	14,890 €	21

* Hauptner



6140/P - 6145/P

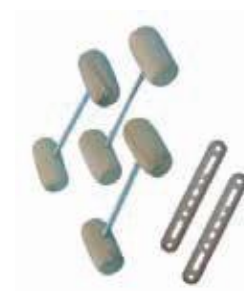

6140/M - 6145/M



6145/H

Cinta de sutura vaginal Bühner

Ref.	Long.	PVP	IVA
7440	5 m	7,590 €	21



Aguja de sutura

Ref.	Modelo	Long.	Calidad	PVP	IVA
7420	Gerlach abierta	15 cm	B	7,990 €	21
7410	Gerlach tubular	20 cm	B	8,990 €	21
7330	Reverdin	19 cm	A - N°1	52,950 €	21
7340	Reverdin	19 cm	A - N°2	52,950 €	21
7310	Deschamps	22 cm	A - Izdo.	22,950 €	21
7315	Deschamps	22 cm	A - Dcho.	22,950 €	21
7430/H	Bühner	23 cm	Hauptner	84,950 €	21
7430	Bühner	30 cm	B	9,890 €	21

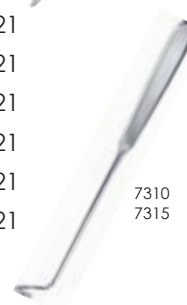

Inyector vacuno

Ref.	Long.	Pajuela	PVP	IVA
6310/A	43 cm	0,25	34,950 €	21
6315/A	43 cm	0,50	35,950 €	21
6315/B	43 cm	0,50	21,950 €	21



Inyector universal vacuno

Ref.	Long.	Pajuela	Marca	PVP	IVA
6320/A	43 cm	0,25 / 0,50	IMV	38,950 €	21
6320/H	48 cm	0,25 / 0,50	Hauptner	69,950 €	21



Inyector Quick Lock 2.000 vacuno

- Apto para todo tipo de vainas y pajuelas

Ref.	Long.	Pajuela	PVP	IVA
6325	42 cm	0,25 / 0,50	39,990 €	21



Inyector Quick Lock clásico

- Apto para utilizar con vainas universales

Ref.	Long.	Pajuela	Uso	PVP	IVA
6326	41 cm	0,25 / 0,50	Vacuno	40,990 €	21
6302	26 cm	0,25 / 0,50	Ovino / Caprino	42,990 €	21



Inyector TE 3 mm para embriones vacuno

- Apto para embriones de 6-7 días

Ref.	Long.	PVP	IVA
6360	54 cm	61,950 €	21



Catéter uterino PVC vacuno

- No estéril

Ref.	Long.	Cant.	PVP	IVA
6345	53,4 cm	25	6,950 €	21



Catéter uterino metal vacuno

Ref.	Long.	PVP	IVA
6348	42 cm	9,950 €	21



Vaina transplante de embriones

- Usar con inyector TE 3 mm 6360

Ref.	Long.	Cant.	PVP	IVA
6351	54 cm	5	10,950 €	21



Vaina universal vacuno

Ref.	Long.	Cant.	Marca	PVP	IVA
6330	44 cm	50	Minitube	3,150 €	21
6330/IMV	44 cm	50	IMV	3,350 €	21



Vaina protectora

- Para evitar contaminaciones

Ref.	Long.	Cant.	PVP	IVA
6350	30 cm	25	8,450 €	21



Vaina universal Alpha IMV vacuno

- Alta seguridad y de uso más rápido y sencillo

Ref.	Long.	Cant.	Marca	PVP	IVA
6375		50	IMV	12,890 €	21



Vaina universal ovino / caprino

Ref.	Long.	Cant.	PVP	IVA
6303	29 cm	50	7,890 €	21



Pipeta inseminación profunda equino

- Flexible con punta redonda

Ref.	Long.	Cant.	PVP	IVA
6425	75 cm	5	9,450 €	21



Sonda uterina Equivet equino

- Estéril

Ref.	Long.	PVP	IVA
6462	190 cm	3,950 €	21



Pajuela

Ref.	Ø	Cant.	PVP	IVA
6443	0,25	2.000	11,950 €	21
6453	0,50	2.000	12,950 €	21



Corta pajuelas

Ref.	PVP	IVA
6355	12,950 €	21



Camisa sanitaria

Ref.	Long.	Cant.	PVP	IVA
6365	54 cm	80	9,890 €	21



Gel lubricante Valueline

Ref.	Capac.	PVP	IVA
6248	1.000 ml	5,650 €	21
6250	5.000 ml	21,950 €	21



Gel lubricante Bovi-vet

Ref.	Capac.	PVP	IVA
6240	500 ml	4,250 €	21
6245	1.000 ml	6,400 €	21
6249	5.000 ml	30,950 €	21



Gel lubricante granulado

- Mezclar con agua para obtener el gel lubricante (12gr en 1L de agua)
- Apto para inseminación y examen rectal o vaginal

Ref.	Capac.	PVP	IVA
6246	350 gr	20,950 €	21



Gel lubricante estéril

- Excelente para instrumental y catéteres, sin espermicida

Ref.	Capac.	PVP	IVA
6655	250 ml	6,350 €	21



Catéter desechable con tapón porcino

Ref.	Long.	PVP	IVA
6680	52 cm	0,230 €	21



Catéter desechable con espuma Goldenpig porcino

Ref.	Long.	PVP	IVA
6670	50 cm	0,187 €	21



Catéter Melrose punto blanco porcino

Ref.	Long.	PVP	IVA
6675	52 cm	8,950 €	21



Catéter intrauterino post-cervical porcino

Ref.	PVP	IVA
6678/l	0,429 €	21



Spray Boarmate

- Mayor posibilidad de éxito en la inseminación artificial
- No se requieren verracos para detectar el celo

Ref.	Capac.	PVP	IVA
5464	80 ml	7,890 €	21
5465	250 ml	17,890 €	21



Toallita desechable limpieza y desinfección porcino

Ref.	Descripción	Cant.	PVP	IVA
6665	Cubo + toallitas	800	23,890 €	21
6665/R	Toallitas de recambio	800	20,890 €	21
6667	Bote + toallitas	150	5,890 €	21



Arco inseminación porcino

Ref.	PVP	IVA
6695	20,890 €	21



Bote clip para semen

Ref.	Capac.	PVP	IVA
6650	80 ml	0,189 €	21



Bote cónico recogida de muestras / semen

- No estéril

Ref.	Capac.	Tapón	PVP	IVA
2158	10 ml	No	0,095 €	21
6405	50 ml	Si	0,212 €	21



2158



6405

Catéter de inseminación para perras

Ref.	PVP	IVA
13695	2,125 €	21



Vagina artificial completa Missouri equino

Ref.	Descripción	PVP	IVA
6415	Vagina completa	325,850 €	21
6416	Bote de recambio	6,950 €	21
6417	Funda desechable	13,950 €	21
6418	Funda interior	215,950 €	21



Vagina artificial completa toros

Ref.	Descripción	PVP	IVA
6430	Vagina completa	88,950 €	21
6434	Válvula de recambio	40,950 €	21
6435	Cono de recambio	29,890 €	21
6436	Funda interior	7,950 €	21



Descongelador de pajuelas

- Alcanza y mantiene la temperatura del agua a 35,6°C
- Apto para usar pajuelas medianas o pequeñas
- **Incluye transformador a red 220V y enchufe de 12V para coche**

Ref.	PVP	IVA
6421	289,950 €	21



Baño maría digital 220V

Ref.	Capac.	PVP	IVA
6630	15 L	339,950 €	21



Cámara de conservación para semen

Ref.	Capac.	Botes	PVP	IVA
6640	70 L	50 - 70	839,950 €	21



Estufa de cultivos

- Rango de T: RT+5-80°C / Resolución: 1°C
- Fluctuación: +/- 0.5°C / Homogeneidad: 2%
- Incluye 2 bandejas de rejilla

Ref.	Medidas ext.	Medidas int.	PVP	IVA
6610	46 x 51 x 69 cm	31 x 31 x 31 cm	1.168,750 €	21



Gel para ecografía

Ref.	Capac.	PVP	IVA
8890	5 L	18,950 €	10



Detector de gestación HK

Ref.	Modelo	PVP	IVA
8810/P	Porcino	496,950 €	21
8810/O	Ovino / Caprino	496,950 €	21



Detector de gestación Hauptner PT-01

Ref.	PVP	IVA
8840	749,950 €	21



Detector de gestación Renco Preg-tone 6

Ref.	PVP	IVA
8855	839,950 €	21



Ecógrafo WED-2000AV porcino

- Pantalla 5" TFT

Ref.	PVP	IVA
8828	2,490,000 €	21



Detector de celo AI Ready

- Autoadhesivo y fácil de aplicar
- Evita falsos positivos asociados a dispositivos de monta única
- Color rojo fácilmente visible



Ref.	Cant.	PVP	IVA
8850/10	10	21,900 €	21

Detector de celo Kamar

Ref.	Cant.	PVP	IVA
8830	25	71,950 €	21



Arnés marcador

Ref.	Ganado	Material	PVP	IVA
11710	Ovino	Nylon	13,950 €	21
11720	Ovino	Cuero	14,950 €	21
11730	Vacuno	Cuero	19,950 €	21



11710



11720



11730

Pastilla para arnés marcador

Ref.	Color	Marca	PVP	IVA
11750	Rojo	Raidex	3,890 €	21
11752	Azul	Raidex	3,890 €	21
11754	Verde	Raidex	3,890 €	21
11756	Amarillo	Raidex	3,890 €	21
11760	Rojo	Top Marker	2,800 €	21
11762	Azul	Top Marker	2,800 €	21
11764	Verde	Top Marker	2,800 €	21
11766	Amarillo	Top Marker	2,800 €	21



Top Marker



Raidex

Mandil para carneros

Ref.	PVP	IVA
11765	9,950 €	21



Espéculo vaginal con iluminación

Ref.	Medidas	PVP	IVA
8521	250 x 30 mm	155,950 €	21
8522	350 x 40 mm	177,950 €	21
8525	420 x 50 mm	185,950 €	21



Espéculo vaginal Polansky

Ref.	Long.	PVP	IVA
8510	37 cm	59,980 €	21



Espéculo vaginal plástico M con cremallera

Ref.	Long.	Long. pico	PVP	IVA
8560	12 cm	115 mm	1,950 €	21



Espéculo nasal Killian

Ref.	Long.	Long. pico	Calidad	PVP	IVA
8530	15 cm	76 mm	A	63,490 €	21
8535	15 cm	76 mm	B	13,950 €	21



Espéculo nasal Hartmann

Ref.	Long.	Long. pico	Calidad	PVP	IVA
8540	15,5 cm	27,5 mm	A	54,950 €	21
8545	15 cm	25 mm	B	13,950 €	21



Limpiador de otoscopios y espéculos

Ref.	PVP	IVA
8550	35,950 €	21



Otoscopio Gowllands

- Mango de acero
- Luz estándar
- 3 espéculos reutilizables (5,6 y 7mm)
- 1 foco de repuesto de 3 voltios
- Estuche rígido
- Pilas no incluidas (LR14 x2)

Ref.	PVP	IVA
8610	129,900 €	21



Otoscopio halógeno Gowllands

- Mango de acero
- Luz halógena
- 3 espéculos reutilizables (5,6 y 7mm)
- 1 foco de repuesto de 3 voltios
- Estuche rígido
- Pilas no incluidas (LR14 x2)

Ref.	PVP	IVA
8615	169,900 €	21



Otoscopio oftalmoscopio Gowllands

- Mango de acero
- 3 espéculos reutilizables (5,6 y 7mm)
- Luz estándar
- Dioptrías (-40,20,15,10,8,6,4,3,2,1,0,1,2,4,6,8,10,15,20,25+)
- 1 Foco de repuesto de 3 voltios
- Estuche rígido
- Pilas no incluidas (LR14 x2)

Ref.	PVP	IVA
8620	149,900 €	21



Otoscopio oftalmoscopio recargable Gowllands

- 2 mangos con batería y resotato
- Luz halógena
- Oftalmoscopio Mayfield con 5 aperturas (-40 a +25 diottrías)
- Otoscopio abierto con lentes gemelas (+4 y +8 diottrías)
- Estuche rígido

Ref.	PVP	IVA
8625	459,900 €	21



Fonendoscopio Hauptner

- Membrana: Ø 65 mm
- Longitud: 85 cm
- Peso neto: 296 gr

Ref.	Descripción	PVP	IVA
8630	Fonendoscopio	119,900 €	21
8630/03	Oliva de repuesto (1 ud)	1,6500 €	21



Fonendoscopio Littmann Classic III

- Membrana: Ø 43 mm
- Doble campana
- Longitud: 69 cm
- Peso neto: 150 gr

Ref.	Descripción	PVP	IVA
8641	Fonendoscopio	164,950 €	21
8640/01	Oliva de repuesto (2 ud)	5,750 €	21



Fonendoscopio Littmann Classic Pediátrico

- Membrana: 35 mm
- Ø diafragma pequeño: 2,5 cm lineales
- Longitud: 71 cm
- Peso neto: 105 gr

Ref.	Descripción	PVP	IVA
8644	Fonendoscopio	159,900 €	21
8640/01	Oliva de repuesto (2 ud)	5,750 €	21



Fonendoscopio económico tipo Littmann

- Membrana: 45 mm
- Campana simple
- Longitud: 65 cm
- Peso campana: 21 gr / Peso neto: 81 gr

Ref.	PVP	IVA
8650	9,950 €	21



Termómetro digital flexible

- Sonda flexible
- Impermeable al agua
- Pila de botón 1,5 V (LR/SR-41) incluida

Ref.	Longitud	Rango T ^a	PVP	IVA
8910/F	13,5 cm	32 °C - 42 °C	5,900 €	21



Termómetro digital

- Impermeable al agua
- Pila de botón 1,5 V (LR/SR-41) incluida

Ref.	Longitud	Rango T ^a	PVP	IVA
8910	12 cm	32 °C - 50 °C	5,500 €	21



Termómetro digital

- Impermeable al agua
- Pila de botón 1,5 V (LR/SR-41) incluida

Ref.	Longitud	Rango T ^a	PVP	IVA
8925	18 cm	32 °C - 43.9 °C	14,890 €	21



Termómetro digital instantáneo

- Muestra la medición entre 10 y 15 segundos
- Precisión: +/- 0.10 °

Ref.	Longitud	Rango T ^a	PVP	IVA
8980	21 cm	32 °C - 44 °C	20,900 €	21



Termómetro digital flexible con luz de alerta

- Números de gran tamaño en pantalla
- Sonda flexible
- Impermeable al agua
- Pila de botón de 3,0 V (CR2032) incluida

Ref.	Longitud	Rango T ^a	PVP	IVA
8912	13 cm	32 °C - 42.9 °C	8,500 €	21



Termómetro para leche

Ref.	Longitud	Rango T ^o	PVP	IVA
8975	19,5 cm	0 °C - 50 °C	4,550 €	21



Termómetro para leche con protector

Ref.	Longitud	Rango T ^o	PVP	IVA
8970	32 cm	-10 °C / 120 °C	7,450 €	21



Termómetro para líquidos

Ref.	Longitud	Rango T ^o	PVP	IVA
8960	30,5 cm	< 100 °C	2,950 €	21
8965	30,5 cm	< 150 °C	3,550 €	21



Termómetro para líquidos con sonda

Ref.	Long. sonda	Rango T ^o	PVP	IVA
9050	15 cm	-40 °C / 270 °C	16,900 €	21



Densímetro de alcohol

Ref.	Longitud	PVP	IVA
8985	27 cm	5,890 €	21



Termómetro ambiente

Ref.	Medidas	Rango T ^a	PVP	IVA
9020	25 x 5,5 cm	-20 °C / 50 °C	1,950 €	21
9030	26 x 8,5 cm	-30 °C / 50 °C	3,800 €	21



9020



9030

Termómetro para frigorífico

Ref.	Medidas	Rango T ^a	PVP	IVA
9025	14,6 x 2,2 cm	-40 °C / 40 °C	3,250 €	21



Termómetro digital máxima y mínima

Ref.	Medidas	Rango T ^a	PVP	IVA
9010	22 x 6 cm	-40 °C / 50 °C	10,950 €	21



Termómetro digital máxima y mínima

- Incluye sonda con cable

Ref.	Rango T ^a	PVP	IVA
9045	- 50 °C / 70 °C	19,900 €	21



Termómetro + Higrómetro digital máxima y mínima

- Incluye sonda con cable

Ref.	Rango T ^a	Rango H ^a	PVP	IVA
9047	- 50 °C / 70 °C	5 / 95 %	29,900 €	21



Termómetro USB

- Precisión: ±1.0°C (±2.0°F)
- Memoria: 16.000 lecturas de temperatura
- Intervalo de registro: 10 sec. a 12 h.

Ref.	Medidas	Rango T ^a	PVP	IVA
9075	9,4 x 3,7 cm	- 35 °C / 80 °C	114,950 €	21



Termómetro + Higrómetro

Ref.	Ø	Rango T ^a	Rango H ^o	PVP	IVA
9040	12,5 cm	5 °C - 35 °C	20 % - 100 %	9,890 €	21



Termómetro + Higrómetro en heno y paja con sonda

- Longitud sonda: 55 cm

Ref.	Rango T ^a	Rango H ^o	PVP	IVA
8955	1 °C - 100 °C	10 % - 80 %	449,950 €	21



Termómetro infrarrojos

- Tiempo de respuesta: < 1 segundo
- Precisión: +/- 2% ó +/- 2°C
- Distancia máxima: 15 cm

Ref.	Rango T ^a	PVP	IVA
8905	-50 °C / 350 °C	55,950 €	21



Pluviómetro

Ref.	PVP	IVA
9055	2,980 €	21
9055/P	2,450 €	21



Medidor de PH y Cloro

Ref.	Rango PH	Rango Cl	PVP	IVA
8990	5.5 - 9	0.2 - 3	33,950 €	21



Báscula de suelo PS 1.000

- Plataforma de acero antideslizante
- Facilita el peso aunque el animal se mueva
- Cable a pantalla de 5 m
- Medidas plataforma: 149,8 x 76,2 x 6,4 cm (55 kg)
- Pantalla LCD con carcasa de acero inox. (incl. soporte para pared)
- Suministro de red o batería 230V (incl. cable de alimentación y baterías)
- Soporte de pie para pantalla opcional

Ref.	Capac.	Lectura	PVP	IVA
13335	1.000 kg	500 gr	1.090,950 €	21
13337	Soporte de pie 1m.		109,850 €	21



Báscula de suelo PS 2.000

- Plataforma de acero de gran superficie
- Facilita el peso aunque el animal se mueva
- Incl. estera de goma antideslizante para una excelente sujeción
- Cable a pantalla de 5 m
- Medidas plataforma: 200 x 100 x 10 cm (135 kg)
- Pantalla LED con carcasa de plástico ABS (incl. soporte para pared)
- Funciona a red o batería 230V (incl. cable de alimentación y baterías)
- Soporte de pie para pantalla opcional

Ref.	Capac.	Lectura	PVP	IVA
13336	1.500 kg	500 gr	1.635,900 €	21
13337	Soporte de pie 1m.		109,850 €	21



Báscula de suelo

- Plataforma de acero lacado
- Facilita el peso aunque el animal se mueva
- Cable a pantalla de 2,7 m
- Funciona a red o batería 230V (incl. cable de alimentación y baterías)

Ref.	Capac.	Lectura	Plataforma	PVP	IVA
13365	150 kg	50 gr	55 x 55 cm	356,950 €	21
13375	150 kg	50 gr	95 x 50 cm	396,950 €	21
13353	300 kg	100 gr	95 x 50 cm	415,950 €	21



Dinamómetro

- Incluye 2 ganchos

Ref.	Capac.	Lectura	PVP	IVA
9120	5 Kg	25 gr	21,900 €	21
9125	10 Kg	50 gr	21,900 €	21
9130	25 Kg	100 gr	21,900 €	21
9135	50 Kg	250 gr	21,900 €	21
9140	100 Kg	500 gr	21,900 €	21
9110	250 Kg	1.000 gr	49,900 €	21



Balanza digital

- EN 13155 / EN 61010-1

Ref.	Capac.	Lectura	Modelo	PVP	IVA
9180	5 Kg	5 gr	1	75,900 €	21
9185	10 Kg	10 gr	1	75,900 €	21
9190	15 Kg	20 gr	2	89,900 €	21
9197	20 Kg	20 gr	3	109,900 €	21
9195	50 Kg	50 gr	2	95,900 €	21
9198	50 Kg	100 gr	3	113,900 €	21
9199	100 Kg	200 gr	3	134,900 €	21



1



2



3

Balanza mini

- Incluye mosquetón y gancho

Ref.	Capac.	PVP	IVA
9170	10 Kg	4,350 €	21
9172	25 Kg	5,350 €	21
9174	50 Kg	6,950 €	21
9181	100 Kg	10,950 €	21



Balanza de precisión

- Plato de pesaje: Ø 15 cm
- Idónea para uso en laboratorio

Ref.	Capac.	Lectura	PVP	IVA
9182	500 gr	0,1 gr	71,900 €	21



Cufómetro

Ref.	Calidad	PVP	IVA
9151	A	69,950 €	21
9153	B	49,950 €	21



Cufómetro revolver Hauptner

Ref.	Modelo	PVP	IVA
9156/H	Analógico	264,950 €	21
9156/HD	Digital	305,850 €	21



Cinta de pesaje

Ref.	Modelo	PVP	IVA
9160	Cerdos / Vacas	6,950 €	21
9161	Vacas lecheras	6,950 €	21
9162	Caballos / Ponys	6,950 €	21



Bastón para medir caballos

Ref.	Calidad	PVP	IVA
9150	A	41,950 €	21
9165	Hauptner	495,950 €	21



Contador de animales

Ref.	PVP	IVA
9175	15,950 €	21



Digestor para triquina completo

Ref.	Descripción	PVP	IVA
9275	Digestor	959,900 €	21
9275/20	Ácido clorhídrico 25% 1 L	14,590 €	21
9275/21	Pepsina 1:10.000 10 gr	4,350 €	21



Placa para triquinoscopio Hauptner

Ref.	Campos	PVP	IVA
9267	28	48,950 €	21



Microscopio binocular URA 40 x 1.600

Ref.	Descripción	PVP	IVA
9220	Microscopio	565,900 €	21
9220/M	Maletín de madera	49,950 €	21



Bombilla

Ref.	Modelo	PVP	IVA
9220/03	Microscopio 6V 20W	11,900 €	21
9252	Triquinoscopio 6V 30W	39,950 €	21



9220/03



9252

Placa para microscopio

- Cajas de 50 uds

Ref.	Medidas	Bordes	Bandas	PVP	IVA
9230	76 x 26 mm	Cortados	Transparentes	2,480 €	21
9235	76 x 26 mm	Esmerilados	Mates	3,150 €	21



9230

9235

Cubreobjetos para microscopio

- Cajas de 100 uds

Ref.	Medidas	PVP	IVA
9243	18 x 18 mm	2,950 €	21
9240	24 x 24 mm	2,950 €	21
9242	32 x 24 mm	3,950 €	21
9241	48 x 24 mm	4,950 €	21



Cámara de recuento Bürker

Ref.	Líneas	PVP	IVA
9225/C	Claros	69,900 €	21
9225/O	Oscuras	30,950 €	21



Caja para instrumental

- Acero inox.
- Tapa y asas de cierre

Ref.	Medidas	PVP	IVA
7301	16 x 10 x 4 cm	35,890 €	21
7302	20 x 10 x 5 cm	49,890 €	21
7303	25 x 15 x 5 cm	59,890 €	21



Caja para instrumental perforada

- Acero inox.
- Tapa y asas de cierre

Ref.	Medidas	PVP	IVA
7306	16 x 10 x 4 cm	59,890 €	21
7307	20 x 10 x 5 cm	66,890 €	21
7308	25 x 15 x 5 cm	75,890 €	21



Bandeja para instrumental

- Acero inox.
- Asas plegables

Ref.	Medidas	PVP	IVA
7371	30 x 22 x 7,5 cm	44,950 €	21
7372	35 x 26 x 7,8 cm	50,950 €	21



Paño para campo desechable

Ref.	Medidas	Modelo	PVP	IVA
13570	50 x 50 cm	No estéril	0,319 €	21
13572	75 x 100 cm	No estéril	0,790 €	21
13574	100 x 150 cm	No estéril	1,490 €	21
13576	75 x 100 cm	Estéril	1,190 €	21
13578	100 x 150 cm	Estéril	2,190 €	21



Envases de esterilización desechables

- Caja de 100 uds

Ref.	Medidas	PVP	IVA
7360	36 x 13 cm	15,900 €	21



Mangos de bisturí

Ref.	Nº	Hoja	Calidad	PVP	IVA
6730	3	10 - 15	B	0,950	21
6740	4	18 - 24	B	1,050 €	21
6760	7	10 - 15	A	14,950 €	21



Mango plegable de bisturí

Ref.	Nº	Hoja	PVP	IVA
6751	3	10 - 15	2,950 €	21
6750	4	18 - 24	2,950 €	21



Hojas de bisturí

- Caja de 100 uds

Ref.	Nº	Calidad	PVP	IVA
6769	10	A	12,900 €	21
6770	11	A	12,900 €	21
6783	15	A	12,900 €	21
6787	20	A	12,900 €	21
6788	21	A	12,900 €	21
6790	22	A	12,900 €	21
6790/A	22	Aesculap	16,950 €	21
6795	24	A	12,900 €	21

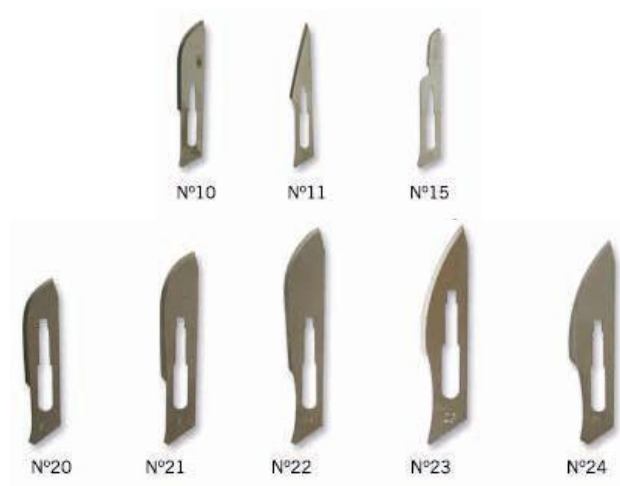

Bisturí desechable

- Caja de 10 uds

Ref.	Nº	PVP	IVA
6710	22	4,950 €	21



Bisturí

Ref.	Calidad	PVP	IVA
6721	B	4,950 €	21



Cauterizador

Ref.	PVP	IVA
7455	69,900 €	21



Tijera cirugía recta punta roma / roma

Ref.	Longitud	Calidad	PVP	IVA
6810	14 cm	A	26,950 €	21
6815	14 cm	B	1,990 €	21
6816	17 cm	B	2,590 €	21



Tijera cirugía recta punta roma / aguda

Ref.	Longitud	Calidad	PVP	IVA
6820	14 cm	A	26,950 €	21
6825	14 cm	B	1,990 €	21
6826/H	16 cm	Hauptner	34,950 €	21
6826	17 cm	B	2,590 €	21



Tijera cirugía recta punta aguda / aguda

Ref.	Longitud	Calidad	PVP	IVA
6830	14 cm	A	26,950 €	21
6835	14 cm	B	2,290 €	21
6836/H	16 cm	Hauptner	29,950 €	21
6836	17 cm	B	2,890 €	21



Tijera cirugía curva punta roma / roma

Ref.	Longitud	Calidad	PVP	IVA
6840	14 cm	A	26,950 €	21
6845	14 cm	B	1,990 €	21
6846/H	16 cm	Hauptner	29,950 €	21
6846	17 cm	B	2,590 €	21



Tijera cirugía curva punta roma / aguda

Ref.	Longitud	Calidad	PVP	IVA
6850	14 cm	A	26,950 €	21
6855	14 cm	B	1,990 €	21
6856/H	16 cm	Hauptner	29,950 €	21
6856	17 cm	B	2,590 €	21



Tijera cirugía curva punta aguda / aguda

Ref.	Longitud	Calidad	PVP	IVA
6860	14 cm	A	26,950 €	21
6865	14 cm	B	2,290 €	21
6866/H	16 cm	Hauptner	32,950 €	21
6866	17 cm	B	2,890 €	21



Tijera disección "Metzenbaum"

Ref.	Longitud	Calidad	PVP	IVA
6870	15 cm	A	29,950 €	21
6872	15 cm	B	3,900 €	21
6875	18 cm	A	33,950 €	21
6873	18 cm	B	4,900 €	21



Tijera "Mayo - Stille" recta

Ref.	Longitud	Calidad	PVP	IVA
6910	17 cm	A	29,950 €	21
6912	17 cm	B	4,950 €	21



Tijera "Mayo - Stille" curva

Ref.	Longitud	Calidad	PVP	IVA
6920	17 cm	A	32,950 €	21
6915	17 cm	B	4,950 €	21



Tijera "Iris" recta

Ref.	Longitud	Calidad	PVP	IVA
6970	11 cm	A	25,950 €	21
6971	11 cm	B	2,950 €	21



Tijera "Iris" curva

Ref.	Longitud	Calidad	PVP	IVA
6972	11 cm	A	24,950 €	21



Tijera para microcirugía

Ref.	Longitud	Calidad	PVP	IVA
6962	12 cm	A	49,950 €	21



Tijera para puntos

Ref.	Longitud	Calidad	PVP	IVA
6966	9 cm	B	2,250 €	21
6955	11 cm	A	26,950 €	21
6965	11 cm	B	2,650 €	21
6950	14 cm	A	29,950 €	21
6960	14 cm	B	3,450 €	21



Tijera "Lister" para vendas

Ref.	Longitud	Calidad	PVP	IVA
6948/H	14 cm	Hauptner	41,950 €	21
6940	15 cm	A	32,950 €	21
6945	18 cm	A	37,950 €	21



Tijera "Jesco" para vendas

Ref.	Longitud	Calidad	PVP	IVA
6930	18 cm	B	3,550 €	21



Cizalla para yeso y escayola

Ref.	Longitud	Calidad	PVP	IVA
6980	37 cm	A	162,950 €	21



Cizalla para yeso y escayola

Ref.	Longitud	Calidad	PVP	IVA
6990	23 cm	A	162,950 €	21



Pinza mosquito recta

Ref.	Longitud	Calidad	PVP	IVA
8210	12,5 cm	A	29,950 €	21
8215	12,5 cm	B	2,650 €	21



Pinza mosquito curva

Ref.	Longitud	Calidad	PVP	IVA
8220	12,5 cm	A	31,950 €	21
8225	12,5 cm	B	2,650 €	21



Pinza mosquito recta con diente

Ref.	Longitud	Calidad	PVP	IVA
8240	13 cm	A	32,950 €	21
8245	13 cm	B	2,950 €	21

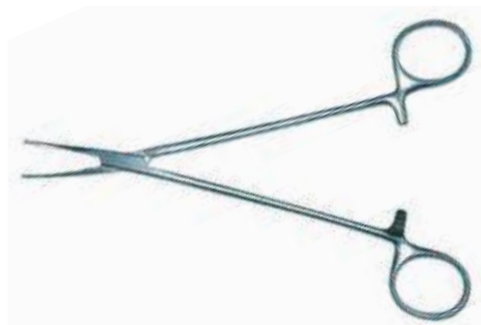

Pinza mosquito curva con diente

Ref.	Longitud	Calidad	PVP	IVA
8230	13 cm	A	32,950 €	21
8235	13 cm	B	2,950 €	21



Separador "Weitlaner"

Ref.	Longitud	Forma	Calidad	PVP	IVA
8250	14 cm	Romo	A	96,950 €	21
8258	14 cm	Agudo	A	79,950 €	21
8255	14 cm	Agudo	B	22,950 €	21



Separador "Senn"

Ref.	Longitud	Modelo	Forma	Calidad	PVP	IVA
8265	16 cm	Rígido	Romo	A	35,950 €	21
8260	16 cm	Rígido	Agudo	A	44,950 €	21
8275	16 cm	Flexible	Romo	A	35,950 €	21
8270	16 cm	Flexible	Agudo	A	44,950 €	21



Pinza hemostática "Pean"

Ref.	Longitud	Calidad	Forma	PVP	IVA
7920	14 cm	A	Recta	29,950 €	21
7925	14 cm	B	Recta	3,950 €	21
7922	14 cm	A	Curva	31,950 €	21



Pinza hemostática "Crile" recta

Ref.	Longitud	Calidad	PVP	IVA
7930	14 cm	A	29,950 €	21
7935	14 cm	B	3,250 €	21



Pinza hemostática "Crile" curva

Ref.	Longitud	Calidad	PVP	IVA
7940	14 cm	A	32,950 €	21
7945	14 cm	B	3,550 €	21



Pinza hemostática "Rochester" recta

Ref.	Longitud	Calidad	PVP	IVA
7956	14 cm	B	3,450	21
7950	16 cm	A	30,950 €	21
7955	16 cm	B	4,450 €	21
7957	18 cm	B	4,950 €	21



Pinza hemostática "Rochester" curva

Ref.	Longitud	Calidad	PVP	IVA
7966	14 cm	B	3,950 €	21
7960	16 cm	A	31,950 €	21
7965	16 cm	B	4,950 €	21



Pinza hemostática "Mayo-Robson" curva

Ref.	Longitud	Calidad	PVP	IVA
7975	18 cm	B	4,490 €	21



Pinza con diente "Kocher" recta

Ref.	Longitud	Calidad	PVP	IVA
8010	16 cm	A	31,950 €	21
8015	16 cm	B	5,250 €	21



Pinza con diente "Kocher" curva

Ref.	Longitud	Calidad	PVP	IVA
8020	16 cm	A	32,950 €	21
8025	16 cm	B	5,950 €	21



Pinza intestinal "Allis"

Ref.	Longitud	Calidad	PVP	IVA
8030	16 cm	A	45,850 €	21
8035	16 cm	B	5,950 €	21



Pinza intestinal atraumática "Babcock"

Ref.	Longitud	Calidad	PVP	IVA
8042	15,5 cm	A	51,750 €	21
8040	22 cm	A	53,750 €	21
8041	22 cm	B	13,950 €	21



Pinza intestinal "Doyen" recta

Ref.	Longitud	Calidad	PVP	IVA
8050	21 cm	A	54,950 €	21
8055	21 cm	B	12,950 €	21



Pinza intestinal "Doyen" curva

Ref.	Longitud	Calidad	PVP	IVA
8060	21 cm	A	56,950 €	21
8065	21 cm	B	14,950 €	21



Pinza para panza "Blendinger"

Ref.	Longitud	Calidad	PVP	IVA
7910	20 cm	A	70,950 €	21



Pinza "Magill"

Ref.	Longitud	Calidad	PVP	IVA
8070	20 cm	A	66,950 €	21
8071	25 cm	B	9,500 €	21



Pinza "Krause" (Polipótomo)

Ref.	Longitud	Calidad	PVP	IVA
7350	26 cm	A	129,950 €	21
7350/P	26 cm	B	29,890 €	21
7350/01	Lazo (12 uds)		6,950 €	21



Pinza porta esponjas "Foerster" recta

Ref.	Longitud	Calidad	PVP	IVA
8110	24 cm	A	46,950 €	21
8116	24 cm	B	12,950 €	21



Pinza porta esponjas "Foerster" curva

Ref.	Longitud	Calidad	PVP	IVA
8115	24 cm	A	48,950 €	21
8117	24 cm	B	13,950 €	21



Pinza "Czerny"

Ref.	Longitud	Calidad	PVP	IVA
8142	20 cm	B	19,950 €	21



Pinza uterina "Museux"

Ref.	Longitud	Calidad	PVP	IVA
8120	24 cm	A	59,950 €	21
8121	24 cm	B	15,950 €	21



Pinza uterina con cabeza de goma

Ref.	Longitud	Calidad	PVP	IVA
8130	16 cm	A	53,950 €	21
8135	19 cm	B	16,950 €	21
8140	28 cm	B	18,950 €	21
8130/H	29 cm	Hauptner	48,950 €	21



Kit para autopsias

- Incl. maletín

Ref.	Calidad	PVP	IVA
8565	A	759,890 €	21



Pinza cocodrilo "Hartmann"

Ref.	Longitud	Calidad	PVP	IVA
8330	14 cm	A	94,950 €	21
8331	14 cm	B	18,950 €	21



Pinza cuerpos extraños "Hartmann"

Ref.	Longitud	Calidad	PVP	IVA
8320	12 cm	A	47,950 €	21
8321	14 cm	B	11,950 €	21



Pinza cuerpos extraños "Buck"

Ref.	Longitud	Calidad	PVP	IVA
8310	11 cm	A	71,950 €	21
8312	14 cm	B	21,950 €	21



Pinza cuerpos extraños "Quire"

Ref.	Longitud	Calidad	PVP	IVA
8315	10 cm	A	71,950 €	21



Pinza de campo "Backhaus"

Ref.	Longitud	Calidad	PVP	IVA
8340	9 cm	A	20,950 €	21
8345	9 cm	B	4,450 €	21
8350	13 cm	A	22,950 €	21
8355	13 cm	B	4,950 €	21



Pinza de campo "Jones"

Ref.	Longitud	Calidad	PVP	IVA
8360	9 cm	A	14,950 €	21
8365	9 cm	B	4,750 €	21



Pinza de disección recta

Ref.	Longitud	Calidad	PVP	IVA
8420	10 cm	B	1,950 €	21
8410	11 cm	A	7,950 €	21
8415	13 cm	A	8,950 €	21
8425	13 cm	B	2,950 €	21



Pinza de disección recta con diente

Ref.	Longitud	Calidad	PVP	IVA
8430	13 cm	A	9,950 €	21
8435	13 cm	B	2,350 €	21
8436	25 cm	B	4,550 €	21



Pinza de disección curva "Gerald"

Ref.	Longitud	Calidad	PVP	IVA
8440	18 cm	A	28,950 €	21
8441	18 cm	B	3,950 €	21



Pinza "Adson"

Ref.	Longitud	Calidad	PVP	IVA
8470	12 cm	A	12,950 €	21
8475	12 cm	B	2,590 €	21



Pinza "Adson" con diente

Ref.	Longitud	Calidad	PVP	IVA
8450	12 cm	A	14,950 €	21
8455	12 cm	B	2,950 €	21



Pinza "Feilchenfeld"

Ref.	Longitud	Calidad	PVP	IVA
8480	11 cm	A	17,950 €	21
8485	11 cm	B	1,350 €	21



Pinza acodada

Ref.	Longitud	Calidad	PVP	IVA
8460	14 cm	B	2,950 €	21



Plexímetro veterinario

Ref.	Longitud	Calidad	PVP	IVA
8710	14,5 cm	B	3,900 €	21



Martillo "Troemner"

Ref.	Longitud	Calidad	PVP	IVA
8720	23 cm	A	44,950 €	21
8721	23 cm	B	12,950 €	21



Martillo "Traube"

Ref.	Longitud	Calidad	PVP	IVA
8730/H	19 cm	Hauptner	36,950 €	21
8730	19 cm	B	12,950 €	21



Martillo "Buck"

- Incluye aguja y cepillo

Ref.	Longitud	Calidad	PVP	IVA
8740	17 cm	B	12,950 €	21



Martillo "Taylor"

Ref.	Longitud	Calidad	PVP	IVA
8750	19 cm	B	7,950 €	21



Porta agujas "Mathieu"

- Boca de tungsteno

Ref.	Longitud	Calidad	PVP	IVA
7510	18 cm	A	104,950 €	21
7511/H	18 cm	Hauptner	139,950 €	21
7512	20 cm	A	113,950 €	21
7512/H	20 cm	Hauptner	156,950 €	21



Porta agujas "Mathieu"

Ref.	Longitud	Calidad	PVP	IVA
7515	14 cm	A	34,950 €	21
7520	18 cm	A	40,950 €	21
7525	18 cm	B	7,900 €	21
7530	20 cm	A	42,950 €	21
7535	20 cm	B	9,900 €	21
7540	24 cm	A	43,950 €	21
7545	24 cm	B	11,250 €	21



Porta agujas "Hegar"

Ref.	Longitud	Calidad	PVP	IVA
7550	18 cm	A	35,950 €	21
7555	18 cm	B	5,900 €	21
7560	20 cm	A	42,950 €	21
7565	20 cm	B	6,900 €	21



Porta agujas "Gillies"

Ref.	Longitud	Calidad	PVP	IVA
7570	16 cm	B	10,950 €	21



Porta agujas "Olsen-Hegar"

Ref.	Longitud	Calidad	PVP	IVA
7580	14 cm	A	74,950 €	21
7581	14 cm	B	8,950 €	21
7582	17 cm	B	10,950 €	21



Aguja sutura curva 1/2 Ethicon FCT ●

- Caja de 12 uds
- Corte circular

Ref.	Nº	PVP	IVA
7012	10 / 12 / 14 / 16 / 18 / 20 / 22 / 24 / 26	39,950 €	21



Aguja sutura curva 1/2 Ethicon FCP ▲

- Caja de 12 uds
- Corte triangular

Ref.	Nº	PVP	IVA
7030	8 / 10 / 14 / 16 / 18 / 20 / 22	45,950 €	21



Aguja sutura curva 3/8 Ethicon FFS ▲

- Caja de 12 uds
- Corte triangular

Ref.	Nº	PVP	IVA
7111	6 / 8 / 10 / 14 / 16 / 18 / 20 / 22	45,950 €	21



Aguja sutura recta Ethicon EST ●

- Caja de 12 uds
- Corte circular

Ref.	Nº	PVP	IVA
7125	0 / 1	45,950 €	21



Aguja sutura recta Ethicon EKS ▲

- Caja de 12 uds
- Corte triangular

Ref.	Nº	PVP	IVA
7130	0 / 1 / 2 / 3 / 4	45,950 €	21



Aguja sutura curva 1/2 "G" ● ▲ ▼

- Caja de 12 uds
- Corte circular, triangular o triangular exterior

Ref.	Nº	Corte	PVP	IVA
7240	000 / 00 / 0	Circular / Triangular	21,950 €	21
7240	1 / 2 / 3 / 4 / 5 / 6 / 7 / 8 / 9 / 10	Circular / Triangular	14,950 €	21
7240	11 / 12 / 13 / 14 / 15 / 16	Triangular	12,950 €	21
7045	000	Triangular exterior	21,950 €	21



Aguja sutura curva 3/8 "B" ● ▲ ▼

- Caja de 12 uds
- Corte circular, triangular o triangular exterior

Ref.	Nº	Corte	PVP	IVA
7210	000 / 00 / 0	Circular / Triangular	21,950 €	21
7210	1 / 2 / 3 / 4 / 5 / 6 / 7 / 8 / 9 / 10	Circular / Triangular	14,950 €	21
7210	11 / 12 / 13 / 14 / 15 / 16	Triangular	12,950 €	21
7010	000 / 00 / 0	Triangular exterior	21,950 €	21



Aguja sutura recta "PM/C" ▲

- Caja de 12 uds
- Corte triangular

Ref.	Nº	PVP	IVA
7291	4 / 5 / 6	39,950 €	21



Aguja sutura autopsias "PM/A" ▲

- Caja de 12 uds
- Corte triangular

Ref.	Nº	PVP	IVA
7280	1 / 2 / 3 / 4 / 5 / 6	45,950 €	21



Aguja sutura autopsias "PM/S" ▲ ▼

- Caja de 12 uds
- Corte triangular o triangular exterior

Ref.	Nº	Corte	PVP	IVA
7270	1 / 2 / 3 / 4 / 5 / 6	Triangular	56,950 €	21
7070	6	Triangular exterior	59,950 €	21



Seda estéril con aguja

- 12 sobres de 150 cm
- No reabsorbible
- **Aguja curva circular 1/2 CHR o triangular 3/8 TDS**

Ref.	USP	Métrica	Aguja	PVP	IVA
7640	2/0	3	CHR30 / TDS30	19,950 €	10
7641	0	3,5	CHR30 / TDS30	21,950 €	10
7642	1	4	CHR30 / TDS30	21,950 €	10
7643	2	5	CHR30 / TDS30	22,950 €	10



Seda estéril sin aguja

- 12 sobres de 150 cm
- No reabsorbible

Ref.	USP	Métrica	PVP	IVA
7631	2/0	3	17,950 €	10
7632	0	3,5	18,950 €	10
7633	1	4	18,950 €	10
7634	2	5	18,950 €	10
7636	3 - 4	6	19,950 €	10
7638	6	8	21,950 €	10



Seda estéril carrete

- No absorbible

Ref.	USP	Métrica	Longitud	PVP	IVA
7819	2/0	3	100 m	28,950 €	10
7820	0	3,5	100 m	30,950 €	10
7822	2	5	75 m	39,950 €	10
7824	4	6	60 m	33,950 €	10
7826	6	8	40 m	33,950 €	10
7827	7	9	30 m	36,950 €	10



Seda no estéril carrete

- No absorbible

Ref.	USP	Métrica	Longitud	PVP	IVA
7650	2	5	10 m	4,950 €	10
7651	2	5	25 m	9,900 €	10
7652	4	6	10 m	5,300 €	10
7653	4	6	25 m	10,500 €	10
7654	6	8	10 m	7,950 €	10
7655	6	8	25 m	11,800 €	10



Catgut cromado estéril con aguja

- 12 sobres de 75 cm
- Absorbible
- **Aguja curva circular 1/2 CHR o triangular 3/8 TDS**

Ref.	USP	Métrica	Aguja	PVP	IVA
7615	2/0	3,5	CHR26 / TDS24	26,950 €	10
7618	0	4	CHR26 / TDS24	26,950 €	10
7621	1	5	CHR26 / TDS24	26,950 €	10
7624	2	6	CHR40 / TDS40	29,950 €	10



Catgut cromado estéril sin aguja

- 12 sobres de 150 cm
- Absorbible

Ref.	USP	Métrica	PVP	IVA
7601	2/0	3,5	23,950 €	10
7604	0	4	23,950 €	10
7607	2	6	30,950 €	10
7610	4	8	39,950 €	10
7613	6	10	44,950 €	10



Catgut cromado estéril carrete

- Absorbible

Ref.	USP	Métrica	Longitud	PVP	IVA
7809	2/0	3,5	100 m	79,950 €	10
7810	0	4	100 m	83,950 €	10
7812	2	6	50 m	68,950 €	10
7814	4	8	30 m	62,950 €	10
7815	5	9	30 m	63,950 €	10
7816	6	10	30 m	70,950 €	10



Supramid estéril carrete

- No absorbible

Ref.	USP	Métrica	Longitud	PVP	IVA
7830	0	3,5	100 m	33,950 €	10
7832	2	5	75 m	38,950 €	10
7834	4	6	40 m	29,950 €	10
7835	5	7	40 m	32,950 €	10
7836	6	8	25 m	29,950 €	10



P.G.A. estéril con aguja

- 12 sobres de 150 cm
- Absorbible
- **Aguja curva triangular 3/8 TDS**

Ref.	USP	Métrica	Aguja	PVP	IVA
7775	2/0	3	TDS19	41,950 €	10
7780	2/0	3	TDS30	44,950 €	10
7785	0	3,5	TDS30	45,950 €	10
7790	2	5	TDS30	46,950 €	10



P.G.A. estéril sin aguja

- 12 sobres de 150 cm
- Absorbible

Ref.	USP	Métrica	PVP	IVA
7750	0	3,5	41,950 €	10
7755	2	5	57,950 €	10
7760	3 - 4	6	58,950 €	10
7765	6	8	63,950 €	10



P.G.A. estéril carrete

- Absorbible

Ref.	USP	Métrica	Longitud	PVP	IVA
7710	0	3,5	25 m	50,950 €	10
7720	2	5	25 m	61,950 €	10
7725	3 - 4	6	25 m	64,950 €	10
7735	6	8	25 m	72,950 €	10



Grapadora desechable

- 35 grapas

Ref.	Marca	Grapa	PVP	IVA
7460/S	SMI	6,4 x 4,0 mm	8,950 €	21
7460/K	Kruuse	6,5 x 4,7 mm	15,950 €	21



7460/S



7460/K

Pinza quitagrapas

Ref.	PVP	IVA
7470	4,950 €	21



Cubre barbas desechable

Ref.	Cant.	PVP	IVA
11209	100	5,950 €	21



Gorro desechable

Ref.	Cant.	Color	PVP	IVA
11260/BL	100	Blanco	4,900 €	21
11260/V	100	Verde	5,400 €	21



Mascarilla desechable

Ref.	Cant.	PVP	IVA
11205	100	3,150 €	21
11207	50	3,950 €	21



Mascarilla con filtro

Ref.	Protección	PVP	IVA
11212	FFP2	2,900 €	21
11213	FFP3	4,500 €	21
11214	FFP3 3M	7,900 €	21



Mascarilla para gases

- Incluye 2 filtros A1
- Brida ajustable
- EN140

Ref.	Descripción	PVP	IVA
11250	Mascarilla	25,950 €	21
11252	Filtro A1	5,890 €	21
11253	Filtro A1-B1-E1-K1	6,890 €	21
11254	Filtro P3	7,890 €	21



Mascarilla con pantalla para gases

- Incluye 1 filtro,
- Válvula de respiración, brida ajustable y membrana fónica
- EN140, EN148-1, DIN 3138

Ref.	Descripción	PVP	IVA
11255	Mascarilla	129,950 €	21
11256	Filtro A2-B2-E2-K2-P3	31,890 €	21



Bota Techno Boot

- TPU
- Específica para uso en ganadería y agricultura
- Resistente y ligera
- Económica
- Suela antideslizante

Ref.	Tallas	Color	Puntera	Suela	PVP	IVA
4280	37 - 46	Verde	No	No	39,950 €	21



Bota Techno Boot de seguridad

- TPU
- Específica para uso en ganadería y agricultura
- Resistente y ligera
- Económica
- Suela antideslizante
- Punta de seguridad de acero

Ref.	Tallas	Color	Puntera	Suela	PVP	IVA
4285	37 - 46	Verde	Si	No	44,950 €	21



Bota cubrecalzado OnGuard

- PVC

Ref.	Talla	PVP	IVA
4225	S	40,950 €	21
4228	M	40,950 €	21
4230	L	40,950 €	21
4235	XL	40,950 €	21



Bota Bekina Steplite X

- TPU
- Específica para uso en sector alimenticio
- Robusta, resistente, ligera y cómoda
- Agarre óptimo en suelos mojados

Ref.	Tallas	Color	Puntera	Suela	PVP	IVA
4207	38 - 44	Blanco	No	No	50,950 €	21



Bota Bekina Steplite X

- TPU
- Específica para uso en ganadería y agricultura
- Robusta, resistente, ligera y cómoda
- Agarre óptimo en suelos mojados y embarrados

Ref.	Tallas	Color	Puntera	Suela	PVP	IVA
4250	36 - 46	Verde	No	No	50,950 €	21



Bota Bekina Steplite X de seguridad

- TPU
- Específica para uso en ganadería y agricultura
- Robusta, resistente, ligera y cómoda
- Agarre óptimo en suelos mojados y embarrados
- Puntera de seguridad de acero

Ref.	Tallas	Color	Puntera	Suela	PVP	IVA
4205	36 - 46	Verde	Si	No	57,950 €	21



Bota Bekina Steplite Xci de seguridad

- TPU
- Específica para uso en ganadería y agricultura
- Indicada para su uso en invierno
- Robusta, resistente, ligera y cómoda
- Agarre óptimo en suelos mojados y embarrados
- Talón amortiguador
- Puntera y plantilla de seguridad de composite

Ref.	Tallas	Color	Puntera	Suela	PVP	IVA
4270	38 - 46	Verde	Si	Si	74,950 €	21



Bota Bekina Thermolite de seguridad

- TPU
- Específica para uso en ganadería y agricultura
- Indicada para frío extremo
- Robusca, resistente, ligera y cómoda
- Agarre óptimo en suelos mojados y embarrados
- Talón amortiguador
- Suela gruesa para un mayor aislamiento del suelo
- Puntera de seguridad de acero

Ref.	Tallas	Color	Puntera	Suela	PVP	IVA
4260	39 - 46	Verde	Si	No	79,950 €	21



Plantilla para botas

Ref.	Tallas	Marca	PVP	IVA
4265	36 - 46	Bekina	5,250 €	21
4282	37 - 46	Techno Boot	3,900 €	21



Botas altas desechables

Ref.	Cant.	Modelo	PVP	IVA
11220	25 pares	Lazo al tobillo	13,950 €	21
11223	25 pares	Goma de ajuste	9,310 €	21



Cubre zapatos desechables plástico

Ref.	Cant.	Color	PVP	IVA
11220/V	100	Verde	2,945 €	21
11220/AZ	100	Azul	2,945 €	21



Cubre zapatos desechables polipropileno

- Aptas para la recogida de muestras

Ref.	Cant.	Color	PVP	IVA
11230/T	100	Verde	6,900 €	21



Gafas de protección

Ref.	Modelo	PVP	IVA
11155	Abierta	2,590 €	21
11157	Cerrada	1,900 €	21



Guantes de cuero porcino

- Semiforrado

Ref.	Talla	Cant.	PVP	IVA
11127/10	10	2	2,950 €	21



Guantes de cuero vacuno

- Sin forro, fino acabado

Ref.	Talla	Cant.	PVP	IVA
11105/7	7	2	8,950 €	21
11105/8	8	2	8,950 €	21
11105/9	9	2	8,950 €	21
11105/10	10	2	8,950 €	21
11105/11	11	2	8,950 €	21



Guantes de cuero vacuno EN 338

- Semiforrado, dorso descubierto elástico de spandex

Ref.	Talla	Cant.	PVP	IVA
11115/9	9	2	9,950 €	21
11115/10	10	2	9,950 €	21
11115/11	11	2	9,950 €	21
11115/12	12	2	9,950 €	21



Guantes de cuero vacuno soldador y barbacoa EN 338 + EN 12477 A&B

- Longitud: 35 cm
- Interior forrado, óptima protección contral el calor

Ref.	Talla	Cant.	PVP	IVA
11128/10	10	2	8,950 €	21



Guantes de PVC protección EN 338

- Longitud: 35 cm
- Forro interlock, de algodón
- Uso universal contra grasas y aceites, estanco a líquidos

Ref.	Talla	Cant.	PVP	IVA
11137/10	10	2	3,950 €	21



Guantes de PVC jardinería

- Estampados surtidos

Ref.	Talla	Cant.	PVP	IVA
11129/8	8	2	1,200 €	21
11129/10	10	2	1,200 €	21



Guantes de látex

- Color blanco

Ref.	Talla	Cant.	Modelo	PVP	IVA
6282	S	100	Con polvo	5,990 €	21
6284	M	100	Con polvo	5,990 €	21
6286	L	100	Con polvo	5,990 €	21
6288	XL	100	Con polvo	5,990 €	21
6282/S	S	100	Sin polvo	7,750 €	21
6284/S	M	100	Sin polvo	7,750 €	21
6286/S	L	100	Sin polvo	7,750 €	21
6288/S	XL	100	Sin polvo	7,750 €	21



Guates de látex extra fuertes Aachen Grip

- Color azul oscuro
- Longitud: 29,5 cm

Ref.	Talla	Cant.	PVP	IVA
6232	S	6 - 7	15,990 €	21
6255	M	7 - 8	15,990 €	21
6260	L	8 - 9	15,990 €	21
6285	XL	9 - 10	15,990 €	21



Guantes de látex estériles

- Específicos para cirugía, con microtexturas para un agarre eficiente del instrumental

Ref.	Talla	Cant.	PVP	IVA
6299	7	2	0,890 €	21
6298	7 1/2	2	0,890 €	21
6297	8	2	0,890 €	21



Guantes de polietileno desechables

Ref.	Talla	Cant.	PVP	IVA
6290	Única	100	1,172 €	21



Guantes de nitrilo

- Color azul

Ref.	Talla	Cant.	PVP	IVA
6265	S	100	8,900 €	21
6270	M	100	8,900 €	21
6275	L	100	8,900 €	21
6280	XL	100	8,900 €	21
6287	XXL	100	8,900 €	21



Guantes de nitrilo

- Color negro

Ref.	Talla	Cant.	PVP	IVA
6201	S	100	8,750 €	21
6202	M	100	8,750 €	21
6203	L	100	8,750 €	21
6204	XL	100	8,750 €	21



Guantes de nitrilo extra fuertes Keron

- Color azul
- Longitud: 30 cm

Ref.	Talla	Cant.	PVP	IVA
6221	S	50	15,250 €	21
6222	M	50	15,250 €	21
6223	L	50	15,250 €	21
6224	XL	50	15,250 €	21
6226	XXL	50	15,250 €	21



Guantes de vinilo hipoalérgico

Ref.	Talla	Cant.	Modelo	PVP	IVA
6294	S	100	Con polvo	4,900 €	21
6295	M	100	Con polvo	4,900 €	21
6296	L	100	Con polvo	4,900 €	21
6293	XL	100	Con polvo	4,900 €	21
6294/S	S	100	Sin polvo	5,900 €	21
6295/S	M	100	Sin polvo	5,900 €	21
6296/S	L	100	Sin polvo	5,900 €	21
6293/S	XL	100	Sin polvo	5,900 €	21



Guantes supersensitivos Krutex

- Color naranja
- Longitud: 90 cm
- Apto para examen rectal, inseminación y obstetricia

Ref.	Cant.	PVP	IVA
6220	100	13,950 €	21



Guantes Krutex

- Color verde
- Longitud: 95 cm
- Apto para examen rectal e inseminación

Ref.	Cant.	PVP	IVA
6215	100	10,750 €	21



Guantes protege axila Krutex

- Color verde
- Sujeción por cuello
- Apto para examen rectal e inseminación

Ref.	Cant.	PVP	IVA
6225	50	12,890 €	21



Guantes inseminación

- Color transparente
- Longitud: 92 cm
- Lazo de sujeción
- Apto para examen rectal e inseminación

Ref.	Cant.	PVP	IVA
6230	100	14,250€	21



Guantes inseminación

- Color naranja
- Longitud: 90 cm
- Apto para examen rectal e inseminación

Ref.	Cant.	PVP	IVA
6210	100	7,950 €	21



Guantes supersensitivos

- Color blanco
- Longitud: 90 cm
- Apto para examen rectal e inseminación



Ref.	Cant.	PVP	IVA
6235	100	9,950 €	21

Protector de hombro Kruise

- Poliamida
- Impermeable

Ref.	PVP	IVA
11160	39,950 €	21



Bata desechable Kruise

- Polietileno
- Manga larga

Ref.	Largo	Cant.	PVP	IVA
11110	135 cm	20	22,950 €	21



Delantal desechable Kruise

- Plástico blanco
- Con dispensador

Ref.	Largo	Cant.	PVP	IVA
11120	140 cm	75	23,950 €	21
11125	160 cm	75	25,950 €	21



Bata para partos Kruise

- 69% PVP + 31% nylon poliamida
- Impermeable
- Manga larga
- Cierre de velcro

Ref.	Largo	Talla	PVP	IVA
10920	120 cm	S	87,950 €	21
10922	130 cm	M	87,950 €	21
10924	140 cm	L	88,950 €	21
10926	150 cm	XL	89,950 €	21



Peto con tirantes para partos Kruise

- 69% PVP + 31% nylon poliamida
- Impermeable

Ref.	Talla	PVP	IVA
11045	S	69,950 €	21
11050	M	69,950 €	21
11055	L	69,950 €	21
11060	XL	69,950 €	21



Chaqueta / pantalón para partos Kruise

- 69% PVP + 31% nylon poliamida
- Impermeable
- Cierre de velcro

Ref.	Modelo	Talla	PVP	IVA
10930	Chaqueta	46	76,950 €	21
10932	Chaqueta	50	76,950 €	21
10934	Chaqueta	54	76,950 €	21
10936	Chaqueta	XL	76,950 €	21
10939	Pantalón	XS	49,950 €	21
10940	Pantalón	S	49,950 €	21
10942	Pantalón	M	49,950 €	21
10944	Pantalón	L	49,950 €	21



Delantal para partos Kruise

- 69% PVC + 31% nylon poliamida
- Impermeable

Ref.	Largo	PVP	IVA
10910	110 cm	19,950 €	21
10912	120 cm	19,950 €	21
10914	130 cm	19,950 €	21



Delantal

- PVC
- Impermeable

Ref.	Largo	Color	PVP	IVA
11040/BL	120 cm	Blanco	5,950 €	21
11040/V	120 cm	Verde	5,950 €	21



Bata para ordeño Velvet

- Poliéster, lavable a máquina 40 °C
- Manga larga con puños elásticos
- Cierre en espalda con 2 velcros
- 1 bolsillo en pecho y 2 en caderas

Ref.	Largo	PVP	IVA
10920/V	130 cm	61,950 €	21
10922/V	145 cm	61,950 €	21
10924/V	150 cm	61,950 €	21



Pantalón ripstop

- Poliamida
- Impermeable
- Reflectante
- 2 bolsillos con cierre de velcro

Ref.	Talla	PVP	IVA
10980/S	S	34,950 €	21
10980/M	M	34,950 €	21
10980/L	L	34,950 €	21
10980/XL	XL	34,950 €	21



Buzo desechable blanco / azul

- Polipropileno 50 gr/m²
- Cierre elástico en capucha, puños, cintura y tobillos
- Cierre de cremallera con solapa

Ref.	Talla	PVP	IVA
11130	M	1,990 €	21
11135	L	1,990 €	21
11140	XL	1,990 €	21
11145	XXL	1,990 €	21



Buzo desechable fitosanitario

- Polipropileno 3 capas 65 gr/m²
- Cierre elástico en capucha, puños, cintura y tobillos
- Cierre de cremallera con solapa
- ISO 13982:2005 + A1:2010 / EN 13034:2005 + A1:2009

Ref.	Talla	PVP	IVA
11185/L	L	5,250 €	21
11185/XL	XL	5,250 €	21



Buzo verde microporoso Tipo 4

- Polipropileno no tejido
- Cierre elástico en capucha, puños, cintura y tobillos
- Cierre de cremallera con solapa
- Sectores: agricultura, química, farmacéutica, pintura y limpieza
- EN 340:2003 / EN 1073-2:2002 / EN 1149-5:2008 / EN 14605:2005+A1:2009 / EN 13982-1:2004+A1:2010 / EN 13034:2005+A1:2009

Ref.	Talla	PVP	IVA
11150/L	L	10,950 €	21
11150/XL	XL	10,950 €	21
11150/XXL	XXL	10,950 €	21



Buzo verde 2 cremalleras

- 65% algodón + 35% polyester 245gr/m²
- EN 340:2003

Ref.	Talla	PVP	IVA
11170/XS	XS	28,950 €	21
11170/S	S	28,950 €	21
11170/M	M	28,950 €	21
11170/L	L	28,950 €	21
11170/XL	XL	28,950 €	21
11170/XXL	XXL	28,950 €	21



Juego de números 0-9 Hauptner para nitrógeno

Ref.	Medidas	Mango	PVP	IVA
11820/H	7 cm	Madera	274,950 €	21



Juego de números 0-9 aluminio para pintura

- Mango de metal

Ref.	Medidas	Mango	PVP	IVA
11811	7,5 cm	Metal	13,550 €	21
11810	10 cm	Metal	14,550 €	21



Juego de números 0-9 aluminio para pintura

- Mango de madera

Ref.	Medidas	PVP	IVA
11830	10 cm	17,950 €	21



Pintura para ganado

- Especial para ovino
- Latas de 4 kg

Ref.	Color	PVP	IVA
11740	Rojo	29,950 €	21
11742	Azul	29,950 €	21
11744	Verde	29,950 €	21
11746	Negro	29,950 €	21



Martillo tatuador pletina aluminio

Ref.	Medida	Casillas	PVP	IVA
11532	30 mm	6	26,950 €	21
11534	30 mm	7	26,950 €	21
11519	20 mm	9	27,950 €	21
11520	20 mm	7 x 2	29,950 €	21



Martillo tatuador pletina hierro

Ref.	Medida	Casillas	PVP	IVA
11510	20 mm	4	14,550 €	21
11512	20 mm	5	14,550 €	21
11514	20 mm	7	14,550 €	21
11515	20 mm	5 x 2	16,950 €	21
11516	20 mm	7 x 2	16,950 €	21



Tatuador fijo

Ref.	Medida	Casillas	PVP	IVA
11350	10 mm	5	79,950 €	21
11355	10 mm	7	95,950 €	21



Tatuador fijo con palanca

Ref.	Medida	Casillas	PVP	IVA
11330	10 mm	5	96,950 €	21
11340	10 mm	10	106,950 €	21



Tatuador articulado

Ref.	Medida	Casillas	PVP	IVA
11317	10 mm	5	49,900 €	21
11319	10 mm	8	49,900 €	21
11322	10 mm	10	49,900 €	21
11315	8 mm	7	49,900 €	21
11320	8 mm	8	49,900 €	21
11325	8 mm	10	49,900 €	21



Signos para martillo tatuador 30 mm

Ref.	Descripción	PVP	IVA
11540	Número	3,290 €	21
11542	Juego números 0 - 9	32,900 €	21
11544	Letra	3,290 €	21
11546	Juego letras A - Z	85,540 €	21
11547	Letra neutra	1,790 €	21

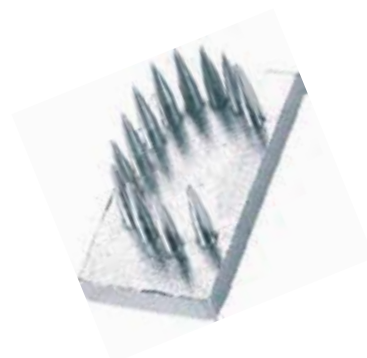

Signos para martillo tatuador 20 mm

Ref.	Descripción	PVP	IVA
11520	Número	2,950 €	21
11522	Juego números 0 - 9	29,50 €	21
11524	Letra	2,950 €	21
11526	Juego letras A - Z	76,700 €	21
11527	Letra neutra	1,350 €	21



Signos para tatuador articulado 10 mm

Ref.	Descripción	PVP	IVA
11420	Número	2,900 €	21
11422	Juego números 0 - 9	29,000 €	21
11424	Letra	2,900 €	21
11426	Juego letras A - Z	75,400 €	21
11427	Letra neutra	1,400 €	21



Signos para tatuador articulado 8 mm

Ref.	Descripción	PVP	IVA
11410	Número	2,690 €	21
11412	Juego números 0 - 9	26,900 €	21
11414	Letra	2,690 €	21
11416	Juego letras A - Z	69,940 €	21
11417	Letra neutra	1,05 €	21



Tatuador Hauptner para perros

Ref.	Medida	Casillas	PVP	IVA
13210	8 mm	7	66,950 €	21



Tatuador Hauptner para gatos y perros pequeños

Ref.	Medida	Casillas	PVP	IVA
13283	5 mm	4	56,950 €	21
13285	5 mm	7	70,950 €	21



Signos para martillo tatuador Hauptner 5 mm

Ref.	Descripción	PVP	IVA
13287	Número	2,850 €	21
13289	Juego números 0 - 9	28,500 €	21
13291	Letra	2,850 €	21
13293	Juego letras A - Z	74,100 €	21
13287/N	Letra neutra	1,190 €	21



Tatuador para gatos

Ref.	Medida	Casillas	PVP	IVA
13230	5 mm	7	114,950 €	21



Signos para martillo tatuador gatos

Ref.	Descripción	PVP	IVA
13240	Número	8,250 €	21
13242	Juego números 0 - 9	82,500 €	21
13244	Letra	8,250 €	21
13246	Juego letras A - Z	164,025 €	21



Tinta para tatuador

Ref.	Capac.	Modelo	Color	PVP	IVA
11450	1 L	Estándar	Negra	17,890 €	21
11499	1 L	Densa	Negra	18,890 €	21



11450



11499

Tinta para tatuador Raidex

Ref.	Capac.	Modelo	Color	PVP	IVA
11450/R	1 L	Estándar	Negra	19,890 €	21
11450/M	1 L	Alimentaria	Marrón	17,890 €	21



11450/R



11450/M

Tinta para tatuador Raidex

Ref.	Capac.	Modelo	Color	PVP	IVA
11460	65 ml	Roll-on	Negra	3,890 €	21
11470	60 gr	Tubo	Negra	4,650 €	21
11474	60 gr	Tubo	Verde	5,650 €	21
11440	600 gr	Bote	Negra	12,200 €	21
11445	600 gr	Bote	Verde	17,900 €	21



11460



11470 - 11474



11440 - 11445

Tampón para tinta

Ref.	PVP	IVA
11850	12,900 €	21



Spray marcador ganado Insprovet

Ref.	Capac.	Color	PVP	IVA
11940	400 ml	Verde	3,179 €	21
11950	400 ml	Azul	3,179 €	21
11960	400 ml	Rojo	3,179 €	21



Spray marcador ovino Insprovet

Ref.	Capac.	Color	PVP	IVA
11936	500 ml	Verde	4,495 €	21
11932	500 ml	Azul	4,495 €	21
11934	500 ml	Rojo	4,495 €	21



Spray marcador ganado Top Marker

Ref.	Capac.	Color	PVP	IVA
11991	500 ml	Verde	4,150 €	21
11992	500 ml	Azul	4,150 €	21
11993	500 ml	Rojo	4,150 €	21
11994	500 ml	Negro	4,150 €	21
11995	500 ml	Naranja	4,150 €	21
11996	500 ml	Violeta	4,150 €	21



Lapiz marcador ganado Top Marker

Ref.	Color	PVP	IVA
11980	Verde	0,890 €	21
11970	Azul	0,890 €	21
11975	Rojo	0,890 €	21
11971	Amarillo	0,890 €	21
11972	Negro	0,890 €	21
11973	Naranja	0,890 €	21
11974	Violeta	0,890 €	21



Spray marcador ganado Raidex

Ref.	Capac.	Color	PVP	IVA
12014	400 ml	Verde	3,350 €	21
12010	400 ml	Azul	3,350 €	21
12012	400 ml	Rojo	3,350 €	21
12016	400 ml	Amarillo	8,750 €	21



Spray marcador ovino Raidex

Ref.	Capac.	Color	PVP	IVA
12015	500 ml	Verde	5,590 €	21
12011	500 ml	Azul	5,590 €	21
12013	500 ml	Rojo	5,590 €	21



Lapiz marcador ganado Raidex

Ref.	Color	PVP	IVA
12028	Verde	1,280 €	21
12020	Azul	1,280 €	21
12022	Rojo	1,280 €	21
12024	Amarillo	1,280 €	21
12026	Negro	1,280 €	21
12040	Naranja	1,280 €	21
12042	Violeta	1,280 €	21
12044	Blanco	1,280 €	21



Spray marcador ganado Porcimark

Ref.	Capac.	Color	PVP	IVA
11930	200 ml	Verde	3,190 €	21
11910	200 ml	Azul	3,190 €	21
11920	200 ml	Rojo	3,190 €	21



Pistola aplicadora para spray marcador

Ref.	PVP	IVA
11990	5,950 €	21



Tijera para marcar ganado

Ref.	Modelo	Calidad	PVP	IVA
11643	Recta	A	27,980 €	21
11640	Recta	B	3,500 €	21
11645	Curva	B	3,500 €	21
11650	Recta *	B	3,750 €	21
11650/C	Curva *	B	3,750 €	21

* con lentilla



Sacabocados corte exterior

Ref.	Corte	Calidad	PVP	IVA
11612	<	B	8,950 €	21
11618	C	B	8,950 €	21
11622	□	B	8,950 €	21
11626	<	A	49,950 €	21
11628	<	B	8,950 €	21
11630	∑	A	49,950 €	21
11632	∑	B	8,950 €	21



Sacabocados corte interior

Ref.	Corte	Calidad	PVP	IVA
11660	△	B	23,950 €	21
11660/C	○	B	23,950 €	21



Sacabocados giratorio

Ref.	Calidad	PVP	IVA
11670	B	7,890 €	



Marca manual

Ref.	Medidas	Material	Color	PVP	IVA
12110/P	55 x 15 mm	Plástico	Amarillo	0,299 €	21



Marca manual Hauptner

Ref.	Medidas	Material	Color	PVP	IVA
12110	55 x 15 mm	Metal	Amarillo	0,257 €	21
12110/BL	55 x 15 mm	Metal	Blanco	0,257 €	21

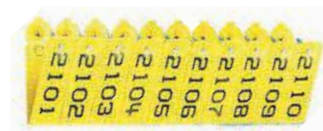

Marca manual para conejos Hauptner

Ref.	Medidas	Material	Cant.	PVP	IVA
12116	10 x 5 mm	Metal	100	25,950 €	21



Marca de laboratorio para conejos Hauptner

Ref.	Medidas	Material	Cant.	PVP	IVA
12118	10 x 4 mm	Metal	100	29,950 €	21



Tenaza para marca de laboratorio

Ref.	Marca	PVP	IVA
12135	12118	83,950 €	21



Marca con enganche ovalado

Ref.	Medidas	Material	PVP	IVA
12120	40 x 12 mm	Metal	0,525 €	21



Tenaza para marca con enganche ovalado

Ref.	Marca	PVP	IVA
12130	12120	124,950 €	21



Collar de plástico con cierre para ovino

Ref.	Medidas	Color	PVP	IVA
12210	61 x 3,5 cm	Verde	1,290 €	21
12212	61 x 3,5 cm	Azul	1,290 €	21
12214	61 x 3,5 cm	Rojo	1,290 €	21
12216	61 x 3,5 cm	Negro	1,290 €	21
12218	61 x 3,5 cm	Amarillo	1,290 €	21
12219	61 x 3,5 cm	Blanco	1,290 €	21
12211	61 x 3,5 cm	Naranja	1,290 €	21



Collar de nylon

Ref.	Medidas	Uso	PVP	IVA
12260	65 x 3 cm	Ovino	0,700 €	21
12267	100 x 3 cm	Vacuno	0,940 €	21



Crotal para collar

Ref.	Medidas	PVP	IVA
12252	9,5 x 4 cm	0,269 €	21



Crotal para colgar

Ref.	Medidas	Color	PVP	IVA
12240	7 x 5,5 cm	Amarillo	0,299 €	21
12242	7 x 5,5 cm	Naranja	0,299 €	21
12241	7 x 5,5 cm	Rojo	0,299 €	21
12230	10,5 x 7,5 cm	Amarillo	0,579 €	21
12232	10,5 x 7,5 cm	Naranja	0,579 €	21
12231	10,5 x 7,5 cm	Rojo	0,579 €	21



Collar de nylon para identificación

Ref.	Medidas	Uso	PVP	IVA
4960	130 x 4 cm	Vacuno	4,490 €	21
4960/0-9	Número del 0 al 9		0,390 €	21



Pulsera de plástico para vacuno

Ref.	Medidas	Color	PVP	IVA
12220	37 x 3,8 cm	Verde	1,790 €	21
12226	37 x 3,8 cm	Azul	1,790 €	21
12224	37 x 3,8 cm	Rojo	1,790 €	21
12222	37 x 3,8 cm	Amarillo	1,790 €	21
12228	37 x 3,8 cm	Naranja	1,790 €	21



Pulsera con cierre de velcro para vacuno

Ref.	Medidas	PVP	IVA
12180	33 x 4 cm	0,690 €	21



Pulsera plástico para ovino

Ref.	Medidas	PVP	IVA
12265	15 x 3 cm	0,270 €	21



Precinto de seguridad

Ref.	Medidas	Brida	PVP	IVA
13800	4,5 x 3,5 cm	30 cm	0,180 €	21



TAMAÑO REAL

Crotal Allflex Maxi

Ref.	Medidas	Modelo
12310	10 x 7,4 cm	Hembra



Crotal Allflex Senior

Ref.	Medidas	Modelo
12340	7,0 x 5,7 cm	Macho
12330	7,7 x 5,7 ,m	Hembra



Crotal Allflex Botón

Ref.	Ø	Modelo
12320	2,8 cm	Macho
12325	2,8 cm	Hembra



TAMAÑO REAL

Crotal Allflex Junior

Ref.	Medidas	Modelo
12360	5,9 x 5,7 cm	Macho
12350	5,9 x 5,7 cm	Hembra



Crotal Allflex Mediano

Ref.	Medidas	Modelo
12354	4,9 x 4,2 cm	Macho
12352	4,9 x 4,2 cm	Hembra



Crotal Allflex Pentag

Ref.	Medidas	Modelo
12380	5,0 x 4,1 cm	Macho
12370	5,0 x 4,1 cm	Hembra



Tenaza universal Allflex

Ref.	Descripción	PVP	IVA
12410	Tenaza	37,950 €	21
12422	Bulón Allflex	5,750 €	21
12420	Bulón compatible	2,500 €	21

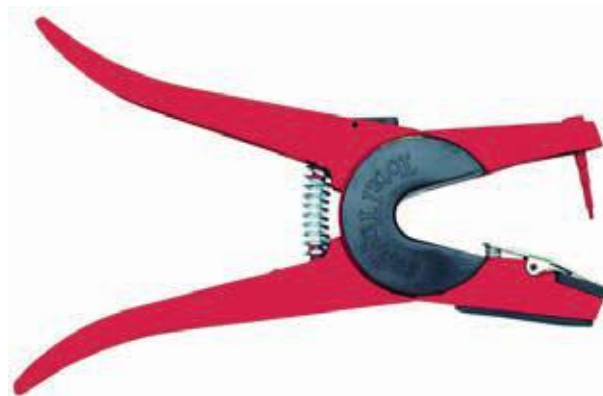

Tenaza automática Allflex Retrac-O-Matic

Ref.	PVP	IVA
12440	139,950 €	21



Rotulador para crotales

Ref.	Punta	Modelo	PVP	IVA
12442	Fina	Artline	2,490 €	21
12450	Doble	Allflex	10,950 €	21



TAMAÑO REAL

Crotal Z-Tag Z1

Ref.	Medidas
12530	11,0 x 7,6 cm



Tenaza Z-Tag

Ref.	Descripción	PVP	IVA
12540	Tenaza	28,890 €	21
12540/01	Bulón	3,950 €	21
12550	Guía colocación	5,950 €	21



12540/01

12550

Rotulador para crotales

Ref.	Punta	Modelo	PVP	IVA
12560	Doble	Z-Tag	7,980 €	21



TAMAÑO REAL

Crotal Cromasa F1

Ref.	Medidas	Modelo
F1	9,7 x 7,5 cm	Hembra



Crotal Cromasa F2

Ref.	Medidas	Modelo
F2	7,5 x 6,0 cm	Hembra



Crotal Cromasa F3

Ref.	Medidas	Modelo
F3	5,0 x 4,5 cm	Hembra



TAMAÑO REAL

Crotal Cromasa F8

Ref.	Medidas	Modelo
F8	5,9 x 5,5 cm	Hembra



Crotal Cromasa F6

Ref.	Medidas	Modelo
F6	4,0 x 3,8 cm	Hembra



Crotal Cromasa F4

Ref.	Medidas	Modelo
F4	3,2 x 3,0 cm	Hembra



Crotal Cromasa F5

Ref.	Ø	Modelo	PVP	IVA
F5	3,0 cm	Hembra		21



TAMAÑO REAL

Crotal Cromasa M8 punta metal

Ref.	Medidas	Modelo
M8	7,5 x 6,0 cm	Macho



Crotal Cromasa M7 punta metal

Ref.	Medidas	Modelo
M7	6,0 x 5,7 cm	Macho



Crotal Cromasa M6 punta metal

Ref.	Medidas	Modelo
M6	4,0 x 3,8 cm	Macho



Crotal Cromasa botón M2 / M3

Ref.	Ø	Modelo	Punta
M2	3,0 cm	Macho	Plástico
M3	3,0 cm	Macho	Metal



M2



M3

TAMAÑO REAL

Crotal para corderos Cromasa CR-M

- Crotal para sacrificio
- Suministrado en tiras de 20 uds (20 machos + 20 hembras)

Ref.	Medidas	Modelo	Tenaza
CRM20	4 x 0,9 cm	Macho + Hembra	12610 / 12640



ES310020130622



Crotal para corderos Cromasa CR-C

- Crotal oficial para sacrificio
- Suministrado en tiras de 10 uds (10 machos + 10 hembras)

Ref.	Medidas	Modelo	Tenaza
CRC	4,5 x 1,5 cm	Macho + Hembra	13010 / 12410



● ES310020130622

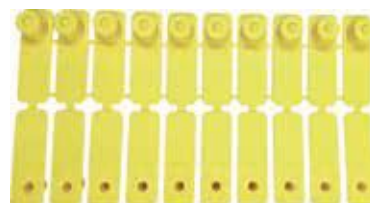

Crotal para lechones Cromasa CR-15

- Suministrado en tiras de 15 uds (15 machos + 15 hembras)

Ref.	Medidas	Modelo	Tenaza
CR15	2,5 x 1,5 cm	Macho + Hembra	13010 / 12410



● ES-2540
NA-2000



Tenaza universal Cromasa con bulón

- Incluye accesorio removible para colocación de crotales CRC para corderos y CR15 para lechones
- Bulón de repuesto incluido

Ref.	Descripción	PVP	IVA
13010	Tenaza	23,920 €	21
13020	Bulón	2,525 €	21
13010/06	Accesorio removible	0,750 €	21

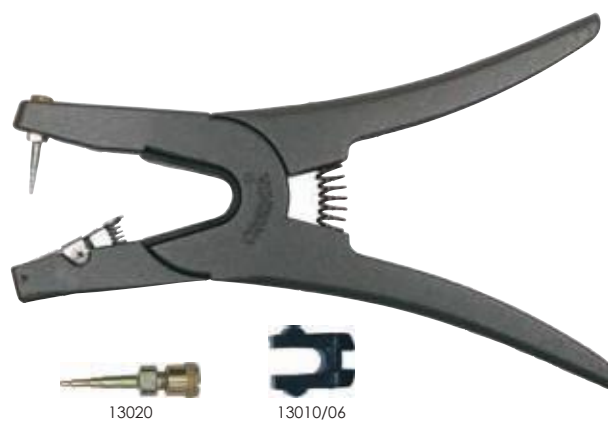

Tenaza CR plástico Cromasa para crotales CRM20

Ref.	PVP	IVA
12610	9,980 €	21



Tenaza CR metal para crotales CRM20

Ref.	PVP	IVA
12640	12,750 €	21



Tenaza MultiFlex para crotales para muestra de ADN

Ref.	PVP	IVA
11301	49,900 €	21



Aplicador para bolos ruminales

- Boquilla a elegir

Ref.	Modelo	PVP	IVA
12425	Aplicador	79,950 €	21
12421	Boquilla bolo	27,950 €	21
12423	Boquilla mini-bolo	27,950 €	21



Jeringa de microchips

- La jeringa es desechable y puede desmontarse fácilmente y sin peligro. Su aguja "Luer-lock" puede separarse del cuerpo de la jeringa para facilitar el tratamiento de los residuos
- Caja con 10 jeringas esterilizadas en bolsas individuales
- Cada caja contiene un listado con los datos de los microchips
- Códigos de barras CODE 128B
- Microchip tipo FDX-B, cumpliendo la normativa ISO 11784 y 11785
- Medidas jeringa: 10,5 x 5,4 x 1,3 cm
- Peso jeringa: 5 gr



Ref.	Microchip	Uso	PVP	IVA
12401	2 x 12 mm	Pequeños animales	36,000 €	21
12405	1,4 x 8,5 mm	Peq. animales + laboratorio	38,000 €	21
12403	3 x 15 mm	Caballos	40,000 €	21

Microchip inyectable

Ref.	Microchip	Cant.	PVP	IVA
12407	3 x 15 mm	100	179,000 €	21
12408	2 x 12 mm	100	169,000 €	21



Pistola para microchip inyectable

- Incluye aguja

Ref.	Microchip	PVP	IVA
12411	3 x 15 mm	29,900 €	21
12413	2 x 12 mm	29,900 €	21



Crotal electrónico

- Suministrado en kits de 10 uds (10 machos + 10 hembras)
- El código del microchip incluido en la pieza es grabado a laser en el anverso del crotal

Ref.	Modelo	Tenaza	PVP	IVA
12470	FDX	13010 / 12410 / 12440	23,900 €	21
12471	HDX	13010 / 12410 / 12440	24,900 €	21



Crotal para muestra de ADN

Ref.	Modelo	Tenaza	PVP	IVA
12402	Hembra	11301	2,100 €	21



Lector de microchips PetScan

- Apto para la identificación de todo tipo de pequeños animales, tales como perros, gatos y también caballos
- Descarga de datos por USB ó Bluetooth
- Distancia de lectura: 20 cm
- Muestra en pantalla los 23 dígitos del identificador electrónico
- Puede leer microchips de tipo FDX-B, FDX-A, Unique y HDX
- Batería interna recargable de Ion/Litio
- Dimensiones : 15,5 x 8 x 3,3 cm
- Peso: 130 gr



Ref.	PVP	IVA
12465	192,900 €	21

Lector de microchips F1

- Ideal para clínicas gracias a su pequeño tamaño y para la identificación de todo tipo de pequeños animales, tales como perros y gatos
- Descarga de datos por USB
- El lector F1 permite la lectura de microchips HDX y FDX-B
- Muestra en pantalla los 23 dígitos del identificador electrónico
- Es el más pequeño del mercado capaz de leer todos los microchips ISO
- Batería interna recargable de Litio
- Dimensiones: 10,7 x 4,8 x 2,4 cm
- Peso: 50 gr



Ref.	Color	PVP	IVA
12485/BL	Blanco	149,900 €	21
12485/V	Verde	149,900 €	21
12485/AZ	Azul	149,900 €	21
12485/R	Rosa	149,900 €	21

Lector de microchips RF4000

- Descarga de datos por Bluetooth
- Almacenamiento de hasta 8.000 registros
- Puede leer microchips de tipo FDX-B y HDX
- Batería interna recargable de Ion/Litio
- Dimensiones : 20 x 9 x 3,5 cm
- Peso: 298 gr



Ref.	Descripción	PVP	IVA
12460	Lector RF4000	849,900 €	21
12464	Amplificador antena	78,900 €	21
12462	Cargador 12 V	34,900 €	21
12463	Cargador 220 V	37,200 €	21



Linterna LED / Halógena

- Selecciona luz LED o halógena con solo apretar un botón
- Batería recargable y asa con diferentes posiciones
- Adaptador de 230 V y cable de carga para el coche de 12 V



Ref.	PVP	IVA
11265	24,950 €	21

Bandeja de plástico para instrumentos

Ref.	Medidas	PVP	IVA
10280	38 x 25 x 11,5 cm	3,950 €	21



Caja de plástico para herramientas

Ref.	Medidas	PVP	IVA
10282	40,6 x 24,4 x 25,2 cm	19,950 €	21



Arnés Maestro 1.0

- Fácil de poner, regulable sin escalas
- Costuras y correa de pecho reflectantes
- Nylon robusto y costuras de gran resistencia

Ref.	Ø Pecho	Ancho	PVP	IVA
81066	30 - 38 cm	15 mm	8,760 €	21
81067	34 - 44 cm	15 mm	9,490 €	21
81068	44 - 55 cm	20 mm	16,150 €	21
81069	55 - 70 cm	25 mm	17,220 €	21
81070	65 - 85 cm	30 mm	20,460 €	21
81071	80 - 109 cm	38 mm	22,640 €	21



Dispensador para bolsas higiénicas

- Incluye 2 rollos de 20 bolsas

Ref.	Medidas	PVP	IVA
83460	6,5 x 4 cm	1,719 €	21



Bolsas higiénicas de repuesto

- 4 rollos de 20 bolsas

Ref.	Color	Biodegradable	PVP	IVA
83459	Negro	No	1,719 €	21
80821	Verde	Si	2,233 €	21



83459



80821

Correa flexi New Comfort - Cordón

- Sistema de frenado corto
- Componentes suaves
- Componentes reflectantes en las tallas S y M
- Las tallas S y M se pueden ampliar con un sistema de iluminación LED y una caja multiusos
- La talla M permite ajustar el tamaño del mango

Ref.	Color	Talla	Peso	Long.	PVP	IVA
80150	Gris	XS	max. 8 kg	3 m	10,450 €	21
80151	Rojo	XS	max. 8 kg	3 m	10,450 €	21
80152	Azul	XS	max. 8 kg	3 m	10,450 €	21
80153	Gris	S	max. 12 kg	5 m	13,960 €	21
80154	Rojo	S	max. 12 kg	5 m	13,960 €	21
80155	Azul	S	max. 12 kg	5 m	13,960 €	21
80156	Gris	S	max. 12 kg	8 m	19,570 €	21
80157	Rojo	S	max. 12 kg	8 m	19,570 €	21
80158	Azul	S	max. 12 kg	8 m	19,570 €	21
80159	Gris	M	max. 20 kg	5 m	14,940 €	21
80160	Rojo	M	max. 20 kg	5 m	14,940 €	21
80161	Azul	M	max. 20 kg	5 m	14,940 €	21
80162	Gris	M	max. 20 kg	8 m	20,570 €	21
80163	Rojo	M	max. 20 kg	8 m	20,570 €	21
80164	Azul	M	max. 20 kg	8 m	20,570 €	21



Correa flexi New Comfort - Cinta

- Sistema de frenado corto
- Componentes suaves
- Se pueden ampliar con un sistema de iluminación LED y una caja multiusos
- Las tallas M y L permiten ajustar el tamaño del mango

Ref.	Color	Talla	Peso	Long.	PVP	IVA
80165	Gris	S	max. 15 kg	5 m	15,790 €	21
80166	Rojo	S	max. 15 kg	5 m	15,790 €	21
80167	Azul	S	max. 15 kg	5 m	15,790 €	21
80168	Gris	M	max. 25 kg	5 m	19,180 €	21
80169	Rojo	M	max. 25 kg	5 m	19,180 €	21
80170	Azul	M	max. 25 kg	5 m	19,180 €	21
80171	Gris	L	max. 60 kg	5 m	29,030 €	21
80172	Rojo	L	max. 60 kg	5 m	29,030 €	21
80173	Azul	L	max. 60 kg	5 m	29,030 €	21
80174	Gris	L	max. 50 kg	8 m	30,860 €	21
80175	Rojo	L	max. 50 kg	8 m	30,860 €	21
80176	Azul	L	max. 50 kg	8 m	30,860 €	21



Correa flexi New Classic - Cordón

- Sistema de frenado corto
- Componentes reflectantes
- Las tallas S y M se pueden ampliar con un sistema de iluminación LED y una caja multiusos

Ref.	Color	Talla	Peso	Long.	PVP	IVA
80272	Negro	XS	max. 8 kg	3 m	8,700 €	21
80273	Rojo	XS	max. 8 kg	3 m	8,700 €	21
80274	Azul	XS	max. 8 kg	3 m	8,700 €	21
80275	Negro	S	max. 12 kg	5 m	10,360 €	21
80276	Rojo	S	max. 12 kg	5 m	10,360 €	21
80277	Azul	S	max. 12 kg	5 m	10,360 €	21
80278	Negro	S	max. 12 kg	8 m	16,135 €	21
80279	Rojo	S	max. 12 kg	8 m	16,135 €	21
80280	Azul	S	max. 12 kg	8 m	16,135 €	21
80281	Negro	M	max. 20 kg	5 m	11,935 €	21
80282	Rojo	M	max. 20 kg	5 m	11,935 €	21
80283	Azul	M	max. 20 kg	5 m	11,935 €	21
80284	Negro	M	max. 20 kg	8 m	17,350 €	21
80285	Rojo	M	max. 20 kg	8 m	17,350 €	21
80286	Azul	M	max. 20 kg	8 m	17,350 €	21



Correa flexi New Classic - Cinta

- Sistema de frenado corto
- Las tallas S y M se pueden ampliar con un sistema de iluminación LED y una caja multiusos

Ref.	Color	Talla	Peso	Long.	PVP	IVA
80287	Negro	XS	max. 12 kg	3 m	11,400 €	21
80288	Rojo	XS	max. 12 kg	3 m	11,400 €	21
80289	Azul	XS	max. 12 kg	3 m	11,400 €	21
80290	Negro	S	max. 15 kg	5 m	13,560 €	21
80291	Rojo	S	max. 15 kg	5 m	13,560 €	21
80292	Azul	S	max. 15 kg	5 m	13,560 €	21
80177	Negro	M	max. 25 kg	5 m	16,900 €	21
80178	Rojo	M	max. 25 kg	5 m	16,900 €	21
80179	Azul	M	max. 25 kg	5 m	16,900 €	21
81106	Negro	L	max. 50 kg	8 m	24,700 €	21
81107	Rojo	L	max. 50 kg	8 m	24,700 €	21
81108	Azul	L	max. 50 kg	8 m	24,700 €	21



Correa flexi New Neon

- Carcasa reflectante
- Se pueden ampliar con una caja multiusos

Ref.	Talla	Peso	Tipo	PVP	IVA
81109	S	max. 12 kg	Cordón	13,450 €	21
81110	M	max. 20 kg	Cordón	15,540 €	21
81180	L	max. 50 kg	Cinta	38,370 €	21



Collar Miami

- Nylon resistente y herrajes robustos
- Impermeable y repelente de suciedad
- Tamaño ajustable
- Cierre de seguridad

Ref.	Color	Ø Cuello	Ancho	PVP	IVA
83716	Negro	20 - 35 cm	10 mm	1,430 €	21
83717	Azul	20 - 35 cm	10 mm	1,430 €	21
83718	Rojo	20 - 35 cm	10 mm	1,430 €	21
82149	Violeta	20 - 35 cm	10 mm	1,430 €	21
82060	Verde	20 - 35 cm	10 mm	1,430 €	21
82061	Naranja	20 - 35 cm	10 mm	1,430 €	21
83700	Negro	30 - 45 cm	15 mm	2,210 €	21
83701	Azul	30 - 45 cm	15 mm	2,210 €	21
83702	Rojo	30 - 45 cm	15 mm	2,210 €	21
82150	Violeta	30 - 45 cm	15 mm	2,210 €	21
82062	Verde	30 - 45 cm	15 mm	2,210 €	21
82063	Naranja	30 - 45 cm	15 mm	2,210 €	21
83704	Negro	40 - 55 cm	20 mm	2,770 €	21
83705	Azul	40 - 55 cm	20 mm	2,770 €	21
83706	Rojo	40 - 55 cm	20 mm	2,770 €	21
82151	Violeta	40 - 55 cm	20 mm	2,770 €	21
82064	Verde	40 - 55 cm	20 mm	2,770 €	21
82065	Naranja	40 - 55 cm	20 mm	2,770 €	21
83708	Negro	45 - 65 cm	25 mm	3,640 €	21
83709	Azul	45 - 65 cm	25 mm	3,640 €	21
83710	Rojo	45 - 65 cm	25 mm	3,640 €	21
82152	Violeta	45 - 65 cm	25 mm	3,640 €	21
82066	Verde	45 - 65 cm	25 mm	3,640 €	21
82067	Naranja	45 - 65 cm	25 mm	3,640 €	21



Correa Miami con asa suave

- Nylon resistente y herrajes robustos
- Impermeable y repelente de suciedad

Ref.	Color	Long.	Ancho	PVP	IVA
83669	Negro	100 cm	20 mm	4,980 €	21
83670	Azul	100 cm	20 mm	4,980 €	21
83671	Rojo	100 cm	20 mm	4,980 €	21
82153	Violeta	100 cm	20 mm	4,980 €	21
82068	Verde	100 cm	20 mm	4,980 €	21
82069	Naranja	100 cm	20 mm	4,980 €	21



Arnés Miami

- Nylon resistente y herrajes robustos
- Impermeable y repelente de suciedad
- 5 opciones de ajuste
- Cierre de seguridad

Ref.	Color	Ø Pecho	Ancho	PVP	IVA
84350	Negro	30 - 40 cm	15 mm	4,960 €	21
84351	Azul	30 - 40 cm	15 mm	4,960 €	21
84352	Rojo	30 - 40 cm	15 mm	4,960 €	21
82157	Violeta	30 - 40 cm	15 mm	4,960 €	21
84354	Negro	40 - 57 cm	15 mm	5,470 €	21
84355	Azul	40 - 57 cm	15 mm	5,470 €	21
84356	Rojo	40 - 57 cm	15 mm	5,470 €	21
82158	Violeta	40 - 57 cm	15 mm	5,470 €	21
84358	Negro	55 - 76 cm	20 mm	6,750 €	21
84359	Azul	55 - 76 cm	20 mm	6,750 €	21
84360	Rojo	55 - 76 cm	20 mm	6,750 €	21
82159	Violeta	55 - 76 cm	20 mm	6,750 €	21
84362	Negro	75 - 100 cm	25 mm	9,560 €	21
84363	Azul	75 - 100 cm	25 mm	9,560 €	21
84364	Rojo	75 - 100 cm	25 mm	9,560 €	21
82160	Violeta	75 - 100 cm	25 mm	9,560 €	21



Correa Miami

- Nylon resistente y herrajes robustos
- Impermeable y repelente de suciedad

Ref.	Color	Long.	Ancho	PVP	IVA
83692	Negro	200 cm	15 mm	5,960 €	21
83693	Azul	200 cm	15 mm	5,960 €	21
83694	Rojo	200 cm	15 mm	5,960 €	21
82154	Violeta	200 cm	15 mm	5,960 €	21
82070	Verde	200 cm	15 mm	5,960 €	21
82071	Naranja	200 cm	15 mm	5,960 €	21
83696	Negro	200 cm	20 mm	7,950 €	21
83697	Azul	200 cm	20 mm	7,950 €	21
83698	Rojo	200 cm	20 mm	7,950 €	21
82155	Violeta	200 cm	20 mm	7,950 €	21
82072	Verde	200 cm	20 mm	7,950 €	21
82073	Naranja	200 cm	20 mm	7,950 €	21
83712	Negro	200 cm	25 mm	10,120 €	21
83713	Azul	200 cm	25 mm	10,120 €	21
83714	Rojo	200 cm	25 mm	10,120 €	21
82156	Violeta	200 cm	25 mm	10,120 €	21
82074	Verde	200 cm	25 mm	10,120 €	21
82075	Naranja	200 cm	25 mm	10,120 €	21



Arnés anti-tiro PetSafe Easy-Walk

- Evita los tirones de correa con rapidez y comodidad
- Es fácil de ajustar y utilizar
- Recomendado por veterinarios y adiestradores
- Máxima comodidad y adaptación fiable
- 4 puntos de ajuste
- Material suave de nylon
- Incluye correa de nylon de 1,8 m y manual de adiestramiento

Ref.	Talla	Ancho ①	Ø Pecho ②	PVP	IVA
87023	XS	15 - 17 cm	31 - 40 cm	12,180 €	21
87024	S	22 - 28 cm	38 - 53 cm	12,640 €	21
87025	M	31 - 38 cm	48 - 66 cm	16,210 €	21
87026	L	41 - 101 cm	69 - 101 cm	19,060 €	21
87027	XL	44 - 56 cm	81 - 127 cm	19,500 €	21



Collar anti-tiro Maxi Coach

- Para guiar y adiestrar el perro más fácilmente
- Utilizar solo en combinación de un collar y una correa

Ref.	Ø Hocico	PVP	IVA
83313	< 24 cm	2,840 €	21
83314	< 32 cm	3,050 €	21
83315	< 38 cm	3,560 €	21
83316	< 44 cm	3,950 €	21
83317	< 54 cm	4,200 €	21
83318	< 34 cm *	4,350 €	21

* especialmente para razas de cabeza corta



Bozal de plástico reforzado

- Especial para Mastines, Rottweilers y Dogos

Ref.	Longitud	Ø Cabeza	PVP	IVA
86200	43 cm	58 - 65 cm	19,650 €	21
86202	46 cm	63 - 70 cm	19,950 €	21



86200



86202

Bozal de plástico galgos

- Diseño alargado específico para galgos
- Colores surtidos

Ref.	Longitud	Modelo	PVP	IVA
13470	22 cm	Cerrado	7,950 €	21
13475	22 cm	Abierto	8,890 €	21



13470



13475

Bozal de nylon

- Fácil de colocar
- Cierre de click
- Correa ajustable
- Lavable en máquina

Ref.	Talla	Raza	PVP	IVA
86205	0 / XS	Yorkie	3,600 €	21
83391	1 / S	Jack Russel	3,600 €	21
83392	2 / M	Border Collie	3,600 €	21
83393	3 / L	Labrador	3,600 €	21
83394	4 / XL	Rottweiler	3,600 €	21
83395	5 / XXL	Mastín	3,600 €	21
83396	*	Boxer	3,600 €	21



Bozal de plástico

- Cierre de click
- Color negro

Ref.	Talla	Ø Hocico	Ø Cabeza	PVP	IVA
83397	XS	21 cm	25 - 38 cm	8,720 €	21
83398	XS/S	22 cm	26 - 43 cm	9,210 €	21
83399	S	23 cm	27 - 45 cm	10,160 €	21
83400	S/M	27 cm	28 - 47 cm	11,230 €	21
83401	M	29 cm	30 - 52 cm	11,710 €	21
83402	M/L	32 cm	32 - 54 cm	12,430 €	21
83403	L	34 cm	34 - 58 cm	13,630 €	21
83404	L/XL	37 cm	35 - 64 cm	15,540 €	21
83405	XL	40 cm	36 - 67 cm	16,020 €	21



Bozal de plástico

- Cierre de hebilla
- Remaches metálicos
- Cinta de sujeción en cuero

Ref.	Ø Hocico	Long. hocico	Ø Cabeza	PVP	IVA
83397/B	18 cm	4 cm	28 - 33 cm	2,410 €	21
83398/B	21,5 cm	5 cm	33 - 38 cm	2,750 €	21
83400/B	24 cm	6 cm	38 - 43 cm	2,930 €	21
83401/B	27 cm	7 cm	40 - 46 cm	3,460 €	21
83402/B	31 cm	7,5 cm	40 - 47 cm	3,840 €	21
83404/B	35 cm	8,5 cm	40 - 48 cm	4,330 €	21
83405/B	39 cm	9 cm	56 - 63 cm	4,960 €	21



Snacks para perros

- Longitud: 2 cm

Ref.	Sabor	Peso	PVP	IVA
81443	Pollo	150 gr	1,450 €	10
81444	Pollo, salmón y panza	150 gr	1,450 €	10
81423	Cordero y arroz	150 gr	1,620 €	10
81445	Carne, verduras y cereal	150 gr	1,620 €	10



81443



81444



81423



81445

Snacks para perros

- Longitud: 2 cm

Ref.	Sabor	Peso	PVP	IVA
81422	Pollo, samón, panza y venado	450 gr	4,580 €	10



81422

Galletas Dinner Bones para perros

- Longitud: 4,5 cm

Ref.	Sabor	Peso	PVP	IVA
81439	Carne de ave, cereales y perejil	500 gr	2,620 €	10



Tiras de carne

- Longitud: 13 cm
- Presentación en bolsa de zip

Ref.	Carne	Peso	PVP	IVA
80707	Pollo	100 gr	2,350 €	10
80708	Pato	100 gr	2,660 €	10
80709	Pollo con barrita de calcio	100 gr	2,520 €	10



80707



80708



80709

Palitos masticables Mix

- Longitud 12,5 cm
- ø 9 – 10 mm
- 90,4 % de piel de vacuno

Ref.	Color	Cant.	PVP	IVA
83334	Surtido	25	1,200 €	10
84076	Surtido	100	3,900 €	10
83332	Rojo	25	1,200 €	10
83973	Rojo	100	3,950 €	10



Palitos masticables

- ø 7 – 8 mm
- Longitud 12,5 cm
- 100 % de piel de vacuno

Ref.	Cant.	PVP	IVA
83346	25	2,240 €	10



Barritas dentales Veggie Snack

- Hechos con productos vegetales y tintes naturales
- Presentación en caja de cartón para su venta individual

Ref.	Longitud	Cant.	PVP	IVA
87028	12 cm	192	53,580 €	10
87029	18 cm	60	55,120 €	10
87030	24 cm	30	57,150 €	10



Huesos de piel

- 100% piel de vacuno

Ref.	Longitud	Cant.	Peso	PVP	IVA
83337	8 cm	8	20 gr	2,170 €	10
83339	10 cm	4	35 gr	1,870 €	10
83340	16 cm	2	90 gr	2,520 €	10
83341	22 cm	2	180 gr	4,580 €	10
83343	30 cm	1	400 gr	4,580 €	10



Hueso de jamón

- 100 % hueso de cerdo
- Envasado al vacío

Ref.	Longitud	Cant.	PVP	IVA
84888	24 cm	1	2,280 €	10



Comedero de acero inoxidable

- Apto para lavavajillas

Ref.	Capac.	Ø	PVP	IVA
83412	450 ml	13 cm	0,920 €	21
83413	900 ml	16 cm	1,350 €	21
83414	1.800 ml	21 cm	2,060 €	21
83415	2.800 ml	25 cm	2,780 €	21
83416	4.000 ml	28 cm	3,710 €	21



Comedero de acero inoxidable

- Antideslizante
- Apto para lavavajillas

Ref.	Capac.	Ø	PVP	IVA
83200	200 ml	11 cm	1,350 €	21
83417	450 ml	15 cm	2,220 €	21
83418	700 ml	16,5 cm	2,730 €	21
83419	900 ml	18,5 cm	3,100 €	21
83420	1.800 ml	22 cm	4,530 €	21
83421	2.800 ml	26 cm	6,250 €	21



Comedero anti ansiedad

- Específico para evitar que coman y beban a toda prisa
- Antideslizante
- Apto para lavavajillas

Ref.	Material	Capac.	PVP	IVA
82294	Acero inox	500 ml	5,670 €	21
80503	Plástico	500 ml	1,830 €	21
80504	Plástico	1.000 ml	3,090 €	21



Comedero doble

- 2 comederos de acero inoxidable
- Comederos aptos para lavavajillas

Ref.	Capacidad	Ø	PVP	IVA
83407	2 x 450 ml	13 cm	3,470 €	21
83408	2 x 900 ml	16 cm	4,900 €	21
83406	2 x 1.800 ml	21 cm	7,140 €	21



Comedero elevado

- Incluye 2 comederos de acero inoxidable y patas
- Comederos regulables en altura sin escalas (max. 43 cm)
- Fijación de comederos
- Comederos aptos para lavavajillas



Ref.	Capacidad	Ø	PVP	IVA
82258	2 x 2.800 ml	25 cm	26,050 €	21

Comederos Multicolor

- Acero inoxidable
- Antideslizante
- Colores surtidos



Ref.	Capac.	Ø	PVP	IVA
82295	200 ml	11 cm	1,900 €	21
82296	450 ml	15 cm	3,190 €	21
82297	900 ml	18,5 cm	4,590 €	21

Comedero automático Maya

- PVC resistente

Ref.	Modelo	Capac.	PVP	IVA
82277	Comedero	1,5 L	4,150 €	21
82279	Comedero	3,5 L	4,550 €	21
82278	Bebedero	1,5 L	4,150 €	21
82280	Bebedero	3,5 L	4,550 €	21



Tolva para perros

- Chapa galvanizada

Ref.	Medidas	PVP	IVA
70710	32,5 x 32,5 x 59 cm	51,040 €	21
70711	41 x 37 x 71,5 cm	97,740 €	21



Férulas de aluminio

- Con almohadilla de espuma
- Pueden doblarse y cortarse para ajustar el tamaño y forma

Ref.	Medidas	PVP	IVA
13511	500 x 15 x 2 mm	9,890 €	21
13512	500 x 20 x 2 mm	11,890 €	21
13513	850 x 30 x 2 mm	15,890 €	21

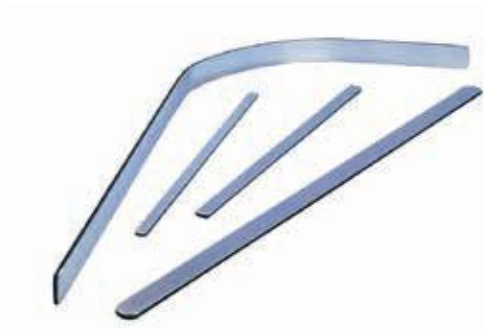

Férulas de PVC

- Ferulas cóncavas de PVC, muy resistentes
- Bordes con espuma de protección densa y que desborda para evitar que se hiera el animal
- Varias líneas de recorte para adaptar la ferula al animal
- Orificios de ventilación para una mejor circulación del aire y para reducir la formación de escaras

Ref.	Longitud	Color	PVP	IVA
13545	200 mm	Azul	5,250 €	21
13546	300 mm	Rojo	6,950 €	21
13547	400 mm	Verde	7,450 €	21



Férulas adaptables

- Muy flexibles, se adaptan a la forma necesaria
- Transparentes a rayos X

Ref.	Medidas	PVP	IVA
13514	250 x 45 mm	4,550 €	21
13515	350 x 55 mm	5,150 €	21
13516	400 x 90 mm	6,100 €	21



Arnés de recuperación trasero Handy-Canis

- Para uso en el caso de inmovilización o parálisis, ligera o severa, temporal o permanente, de las patas delanteras o traseras de los perros y gatos
- Alivia al animal durante sus desplazamientos y, en particular, para ayudarlo a salvar obstáculos (aceras, escalones,...)
- Material muy resistente, elástico, cómodo y lavable
- Ajustable gracias a las tiras de velcro y correas

Ref.	Talla	Raza	PVP	IVA
13580/XS	XS	Yorkshire	38,950 €	21
13580/S	S	Teckel	39,950 €	21
13580/M	M	Basset	40,950 €	21
13580/L	L	Retriever	41,950 €	21
13580/XL	XL	Terranova	44,950 €	21



Collar isabelino Transparente

- Flexible y fácil de colocar

Ref.	Medida	Cant.	PVP	IVA
13310	7,5 cm	10	20,900 €	21
13312	10 cm	10	22,900 €	21
13314	12,5 cm	10	25,900 €	21
13316	15 cm	10	31,900 €	21
13318	20 cm	10	32,900 €	21
13320	25 cm	10	41,900 €	21
13322	30 cm	10	54,900 €	21
13326	35 cm	1	11,900 €	21
13324	40 cm	1	14,500 €	21



Collar isabelino Opaco

- Flexible y fácil de colocar

Ref.	Medida	Cantidad	PVP	IVA
13310/O	7,5 cm	10	18,300 €	21
13312/O	10 cm	10	20,100 €	21
13314/O	12,5 cm	10	23,850 €	21
13316/O	15 cm	10	29,950 €	21
13318/O	20 cm	10	30,250 €	21
13320/O	25 cm	10	38,950 €	21
13322/O	30 cm	10	50,950 €	21
13326/O	35 cm	1	10,650 €	21
13324/O	40 cm	1	12,750 €	21
13323	7,5 - 30 cm	7 (1 de cada)	23,150 €	21



Collar isabelino Transparente con borde

- Borde de goma
- Flexible y fácil de colocar
- Cierre rápido

Ref.	Medida	Cant.	PVP	IVA
13310/B	7,5 cm	5	12,450 €	21
13312/B	10 cm	5	14,300 €	21
13314/B	12,5 cm	5	17,750 €	21
13316/B	15 cm	5	19,150 €	21
13318/B	20 cm	5	21,700 €	21
13320/B	25 cm	5	27,900 €	21
13322/B	30 cm	5	32,800 €	21



Jaula para transporte

- Para utilizar en exposiciones, hoteles, apartamentos...
- Plegable, fácil de montar y desmontar
- Pintura en polvo negra termolacada
- Con asa de transporte
- Bandeja de plástico extraíble para facilitar la limpieza



81364 - 81365 -
81366

Ref.	Medidas	Puertas	PVP	IVA
81364	63 x 48 x 57 cm	1	39,950 €	21
81365	76 x 54 x 64 cm	2	53,950 €	21
81366	92 x 63 x 74 cm	2	75,950 €	21
81367	76 x 54 x 64 cm	2	49,950 €	21
81368	92 x 63 x 74 cm	2	69,100 €	21
81369	107 x 74 x 85 cm	2	99,950 €	21



81367 - 81368 -
81369

Transportín Gulliver 1

- Puerta y cajón de plástico de alta calidad
- Fijación para cinturón de seguridad

Ref.	Color	Medidas	Peso máx.	PVP	IVA
84581	Ciruela / Topo	48 x 32 x 31 cm	6 kg	12,250 €	21



Transportín Expedion

- Puerta y cajón de plástico de alta calidad
- Fijación para cinturón de seguridad

Ref.	Color	Medidas	Peso máx.	PVP	IVA
81346	Crema / Topo	45 x 30 x 30 cm	10 kg	10,800 €	21
81347	Verde / Gris	45 x 30 x 30 cm	10 kg	10,800 €	21
81348	Crema / Burdeos	45 x 30 x 30 cm	10 kg	10,800 €	21
81344	Clips de repuesto + fijaciones y asa			5,250 €	21



Transportín Gulliver

- Plástico de alta calidad
- Puerta metálica y fijación para cinturón de seguridad
- 84652 + 84653 adicionalmente con trampilla para acariciar a la mascota y compartimento para objetos pequeños

Ref.	Medidas	Peso máx.	PVP	IVA
84651	48 x 32 x 31 cm	6 kg	14,650 €	21
84652	55 x 36 x 35 cm	8 kg	21,500 €	21
84653	61 x 40 x 38 cm	12 kg	24,850 €	21
84654	Correa de hombro		6,860 €	21
84655	Juego de ruedas		5,750 €	21
84659	Clips de repuesto		2,850 €	21
84661	Asa de repuesto		0,850 €	21



Transportín Gulliver 3 Top Free

- Con asa y apertura por arriba y por delante
- Cómodas puertas de metal, incluye recipiente para agua
- Mecanismo de fijación para cinturón de seguridad incluido

Ref.	Medidas	Peso máx.	PVP	IVA
84583	61 x 40 x 38 cm	12 kg	43,400 €	21



Transportín Gulliver Mega

- Apto para transporte aéreo, según normativa IATA
- Cómodas puertas de metal
- Recipiente para agua y compartimentos portaobjetos incluidos
- Cierres a presión bloqueables
- Puertas con triple cierre

Ref.	Medidas	Peso máx.	PVP	IVA
84584	70 x 50 x 51 cm	18 kg	72,500 €	21
84585	81 x 61 x 60 cm	25 kg	90,750 €	21
84586	92 x 64 x 66 cm	40 kg	120,550 €	21
84587	102 x 72 x 76 cm	50 kg	135,950 €	21
84588	Juego de ruedas		31,750 €	21
84589	Bebedero 550ml		5,250 €	21



Funda protectora multifunción

- Útil para proteger al perro y el asiento del vehículo
- Apta para todos los vehículos con apoyacabezas
- 2 orificios para cinturones de seguridad
- Divisible por cremallera para dejar espacio para una persona en el asiento trasero
- Fabricada en nylon resistente
- Incluye botella para bebidas y bolsillo para utensilios



Ref.	Longitud	Anchura	PVP	IVA
83252	150 cm	140 cm	21,330 €	21

Arnés de vehículo para perros

- Tejido de nylon suave
- Correa de pecho forrada con espuma
- Adecuado para todo tipo de cierres convencionales
- Incluye la pieza de conexión 83259

Ref.	Ø Pecho	PVP	IVA
83253	30 - 60 cm	7,550 €	21
83254	50 - 70 cm	8,980 €	21
83255	70 - 90 cm	9,830 €	21
83256	80 - 110 cm	10,360 €	21



Enganche para cinturón de seguridad

- Ajuste gradual

Ref.	Longitud	Anchura	PVP	IVA
83259	40 - 60 cm	25 mm	4,020 €	21



Red de separación para vehículos

- Para todos los modelos de vehículo convencionales
- Fácil montaje

Ref.	PVP	IVA
83260	6,030 €	21



Portaperros Towbox Dog V1

- La manera más práctica , sencilla, limpia y cómoda de transportar a sus mascotas. Los perros viajan cómodos y el vehículo queda libre de olores y posibles daños
- Medidas: 1.085 x 585 x 640 cm
- Volumen: 280 L
- Carga útil: 75 kg

Ref.	Color	PVP	IVA
13305/N	Negro	679,900 €	21
13305/V	Verde	679,900 €	21
13305/G	Gris	679,900 €	21



Portaperros Towbox Dog V2

- Tiene mayor capacidad de carga que el V1, con mejoras estéticas y funcionales. Apertura de puertas laterales
- Medidas: 1.180 x 755 x 640 cm
- Volumen: 390 L
- Carga útil: 66 kg

Ref.	Color	PVP	IVA
13300/N	Negro	789,900 €	21
13300/V	Verde	789,900 €	21
13300/G	Gris	789,900 €	21



Placa de señalización metálica

- Homologada y reflectante
- No incluye correas de sujeción

Ref.	Medidas	PVP	IVA
13301	50 x 50 cm	34,950 €	21



Caseta de madera para perros

- Se envía desmontada en una caja de cartón, fácil montaje
- Aislamiento térmico, idónea para verano o invierno

Ref.	Medidas	Material	PVP	IVA
86349	76 x 70 x 76 cm	Madera	124,950 €	21
86350	85 x 73 x 80 cm	Madera	104,950 €	21
86351	102 x 85 x 88 cm	Madera	162,950 €	21
81349	100 x 83 x 94 cm	Plástico	183,950 €	21



Cuna de plástico

- Con orificios de aireación y antideslizantes

Ref.	Medidas	Colchoneta	PVP	IVA
81236	56,5 x 42 x 24 cm	80353	7,950 €	21
81237	68,5 x 49 x 27,5 cm	80354	11,950 €	21
81238	80,5 x 49 x 32 cm	80355	16,450 €	21
81239	88 x 62 x 35,5 cm	80356	22,950 €	21
81240	96 x 68 x 37,5 cm	80357	28,950 €	21
81241	118 x 80 x 39,5 cm	80358	36,950 €	21



Colchoneta de lona

- 60 % algodón + 40 % poliéster
- Reversible, lavable a 30 °C

Ref.	Medidas	PVP	IVA
80353	58 x 43 cm	6,950 €	21
80354	64 x 48 cm	7,950 €	21
80355	72 x 52 cm	10,450 €	21
80356	82 x 57 cm	13,450 €	21
80357	92 x 64 cm	16,250 €	21
80358	105 x 73 cm	20,450 €	21
80359	120 x 85 cm	24,450 €	21



Colchoneta Oxford Place

- Funda repelente al agua y suciedad con cremallera
- Lavable a 30 °C

Ref.	Medidas	Color	PVP	IVA
84990	100 x 70 cm	Azul	31,950 €	21
84992	100 x 70 cm	Marrón	31,950 €	21



Cuna mullida Samuel

- 100 % poliéster, reversible
- Lavable a 30 °C

Ref.	Medidas	Color (int/ext)	PVP	IVA
81315	50 x 40 x 15 cm	Gris oscuro / Gris	12,350 €	21
81317	50 x 40 x 15 cm	Gris oscuro / Verde	12,350 €	21
81316	60 x 50 x 17 cm	Gris oscuro / Gris	17,350 €	21
81318	60 x 50 x 17 cm	Gris oscuro / Verde	17,350 €	21



Valla invisible

- El equipo completo se compone de: Transmisor, 1 collar, 150 metros de cable, banderolas y otros accesorios
- Se delimita el territorio asignado al perro con un cable que parte de un emisor
- El perro lleva colocado un collar educativo. Cuando el perro se aproxima a la zona donde se encuentra el cable, el collar emite un pitido para que el perro no continúe acercándose. Si persiste, se activa y administra al perro un pequeño impulso disuasorio que le obliga a retroceder

Ref.	Alcance	PVP	IVA
13455	1.000 m	249,950 €	21
13466	Collar recambio 1.000 m	107,950 €	21
13467	Collar ficticio	19,950 €	21



Collar de adiestramiento

- Apto para 1 ó 2 perros
- 20 niveles de impulso: continuo, acústico, botón "booster"
- Indicado para uso profesional o doméstico

Ref.	Alcance	PVP	IVA
13415	250 m	219,950 €	21
13419	600 m	249,950 €	21
13421	1.600 m	315,950 €	21
13419/R	Collar de recambio	135,950 €	21



Collar antiladridos D-MUTE

- Sumergible
- Válido para todas las razas de perros y todos los tamaños
- Captador de vibración ajustable para adaptarse mejor a ladridos y aullidos de diferente intensidad
- 6 modos de corrección manual o automático
- Incluye pila de litio de 3V (CR2)
- Correa ajustable de nylon de 17 a 75 cm

Ref.	PVP	IVA
13405	64,950 €	21



Abrebocas para perros

Ref.	Medidas	PVP	IVA
13330	12,5 cm	9,950 €	21
13332	18 cm	10,950 €	21



Depresor lingual

Ref.	Material	Modelo	PVP	IVA
13357	Plástico	Estéril	15,900 €	21
13355	Plástico	No estéril	9,550 €	21
13361	Madera	Estéril	16,900 €	21
13359	Madera	No estéril	3,550 €	21



Introduccion de pastillas

Ref.	Cant.	PVP	IVA
13560	10	15,600 €	21



Guillotina para pastillas

Ref.	PVP	IVA
13550	4,900 €	21



Triturador de pastillas

Ref.	PVP	IVA
13530	6,950 €	21



INSPROVET

Pol. Ind. Morea Sur nº81
31191 Beriain (Navarra)

Tfn. 0034 948 312048

Fax 0034 948 312079

📞 677 334570

<http://www.insprovet.es>

insprovet@insprovet.net

